

# Reference guide for Recurve archers

Originally produced for Grange and Balbardie archery clubs.

Editor: Murray Elliot  
murrayelliot@blueyonder.co.uk

The latest edition of this document may be downloaded from:  
<http://www.archersreference.pwp.blueyonder.co.uk>

Edition: 5  
Issue Date: 16 November, 2002

Copyright ©1999-2002

All information contained herein and copyrights remains with the original authors.  
Because the contributors have given of their time and wisdom freely, no part of this document may be reproduced in part or in whole for any form of gain or profit without the prior consent of the authors.

Any and all modifications must be approved by the authors and all acknowledgements must remain.

<b>1</b>	<b>FOREWORD</b> .....	<b>5</b>
<b>2</b>	<b>EQUIPMENT</b> .....	<b>5</b>
2.1	BOWS .....	5
2.1.1	<i>Technical terms for beginners.</i> .....	6
2.1.2	<i>Selecting the correct bow length</i> .....	7
2.1.3	<i>Risers</i> .....	7
2.1.4	<i>Limbs</i> .....	9
2.1.5	<i>Strings</i> .....	10
2.1.6	<i>Buying a bow</i> .....	19
2.2	ARROWS .....	20
2.2.1	<i>Technical terms for beginners</i> .....	20
2.2.2	<i>Material</i> .....	20
2.2.3	<i>Choosing the correct length</i> .....	21
2.2.4	<i>Choosing the right arrow</i> .....	22
2.2.5	<i>Points</i> .....	22
2.2.6	<i>Fletchings or Vanes</i> .....	24
2.2.7	<i>Nocks</i> .....	25
2.2.8	<i>Maintenance</i> .....	26
2.2.9	<i>Jargon</i> .....	26
2.3	SIGHTS .....	26
2.3.1	<i>Construction/materials</i> .....	26
2.3.2	<i>Cost</i> .....	26
2.3.3	<i>Sight pin/crosshair/sight ring?</i> .....	27
2.3.4	<i>Sightmarks</i> .....	27
2.4	ARROW RESTS .....	27
2.5	PRESSURE BUTTONS .....	27
2.5.1	<i>Setting up a second button.</i> .....	28
2.5.2	<i>Maintenance</i> .....	28
2.6	STABILISERS.....	28
2.7	OTHER ACCESSORIES .....	29
2.7.1	<i>Bracer (arm guard)</i> .....	29
2.7.2	<i>Tab</i> .....	29
2.7.3	<i>Quiver</i> .....	29
2.7.4	<i>Chest Guard</i> .....	30
2.7.5	<i>Slings</i> .....	30
2.7.6	<i>Clicker</i> .....	31
<b>3</b>	<b>TUNING</b> .....	<b>32</b>
3.1	WHAT?.....	32
3.2	WHY?.....	32
3.3	HOW? .....	32
3.3.1	<i>Step 1 – Preliminary Setup</i> .....	32
3.3.2	<i>Step 2 – Bracing Height</i> .....	32
3.3.3	<i>Step 3 – Nocking Point</i> .....	33
3.3.4	<i>Step 4 – Centre Shot</i> .....	34
3.3.5	<i>Step 5 – Arrow spine</i> .....	34
3.3.6	<i>Step 6 – Clearance</i> .....	35
3.3.7	<i>Step 7 – Compensating for incorrect spine</i> .....	35
3.4	ADJUSTING THE TILLER .....	35
3.5	OTHER TUNING METHODS.....	36
3.5.1	<i>Cushion plunger tuning (Vic Berger method)</i> .....	36
3.5.2	<i>Short Distance Tuning, Fine Tuning and Micro tuning</i> .....	36
3.5.3	<i>Tune for tens (a complete tuning guide from Rick Stonebraker)</i> .....	36
<b>4</b>	<b>TECHNIQUE</b> .....	<b>44</b>
4.1	THE BASICS .....	44
4.1.1	<i>Warm up!</i> .....	44
4.1.2	<i>Which hand?</i> .....	44

4.1.3	<i>Aiming – One eye or both eyes?</i> .....	44
4.2	STANCE .....	44
4.3	THE PRE-DRAW .....	45
4.3.1	<i>Nock the arrow, set the drawing and bow hand</i> .....	45
4.3.2	<i>Bow arm &amp; drawing arm</i> .....	46
4.4	THE DRAW AND “ANCHOR” .....	47
4.5	THE RELEASE AND FOLLOW-THROUGH .....	48
4.6	THE BEST STYLE .....	49
4.7	CONCENTRATION (FOCUS) .....	49
4.8	RHYTHM AND MOTION .....	49
<b>5</b>	<b>SOLVING PROBLEMS .....</b>	<b>50</b>
5.1	LOST THE FEEL .....	50
5.2	TARGET PANIC .....	50
<b>6</b>	<b>TRAINING .....</b>	<b>51</b>
6.1	PHYSICAL TRAINING .....	51
6.1.1	<i>Using the formaster®</i> .....	51
6.1.2	<i>Using the bow without shooting</i> .....	52
6.1.3	<i>Using the bow</i> .....	53
6.1.4	<i>Other exercises for archers</i> .....	53
6.2	MENTAL TRAINING .....	54
6.2.1	<i>Imagery</i> .....	54
6.2.2	<i>Positive Self-talk</i> .....	54
<b>7</b>	<b>TYPES OF ARCHERY .....</b>	<b>55</b>
7.1	TARGET.....	55
7.1.1	<i>Basic Competition Rules</i> .....	55
7.1.2	<i>Competition Preparation</i> .....	58
7.2	CLOUT.....	58
7.3	FIELD .....	58
7.4	POPINJAY (PAPINGO).....	60
7.5	FLIGHT .....	60
7.6	OTHER ROUNDS.....	60
<b>8</b>	<b>MODERN HISTORY (THE LAST 30 YEARS).....</b>	<b>60</b>
8.1	THE OLYMPICS.....	60
8.2	EQUIPMENT HISTORY .....	62
8.3	MODERN EQUIPMENT COMES OF AGE .....	62
8.3.1	<i>Hoyt</i> .....	63
<b>9</b>	<b>REFERENCE MATERIAL .....</b>	<b>63</b>
9.1	BOOKS .....	63
9.2	VIDEOS.....	63
9.3	THE INTERNET .....	64
<b>10</b>	<b>GLOSSARY OF ARCHERY TERMS .....</b>	<b>65</b>
<b>11</b>	<b>ACKNOWLEDGEMENTS.....</b>	<b>67</b>

## **1 Foreword**

Archery is a science, and an art. Much has been written about archery down the years and there are many schools of thought regarding the “right” technique, but there is no right technique. There are hints and tips which many thousands of archers have used successfully over the years to help them find a way of repeating the same thing time, and time, and time, and time.... again! The purpose of this document is to demystify the art, explain the science and hopefully provide some of those useful hints and tips.

All of the information in this document has been gathered from a variety of sources including: Other archers, books, and (probably most of all) the internet. I take no credit whatsoever for the content and wisdom contained herein.

The information contained here is mainly orientated towards Olympic archery (Recurve), since that is my primary discipline, but it is my intention to expand this, as and when information becomes available.

## **2 Equipment**

This section is intended to provide the beginner and experienced archer, alike, with some insight into the various types of equipment available to us. Like all other sports, this information will quickly become out of date as progress is made in the design of better, lighter, stronger, more forgiving materials and their uses.

The ultimate attraction for some archers is not to shoot the best scores, but to have the best equipment - the shiniest riser, the most expensive limbs, the newest, most complicated looking sight. The "techno-archer" proliferates the shooting lines, but all archers should remember that no matter what we are shooting, the arrow will only go where we put it, and most equipment setups today are far and beyond the capabilities of their owner in terms of accuracy and consistency. Will we shoot better with a multi-rod stabiliser, a carbon riser and carbon/foam limbs? Maybe a little, but at the end of the day these things only make a difference to a good archer. Improving form and technique will produce a much more dramatic result than playing with new “toys”.

Having said that, archery is almost as much a mind game as it is a physical one, and therefore anything that can increase the archer’s self-confidence is good. If owning that nice shiny new bow will make you feel good, then go for it, but remember, there's nothing worse than buying a nice shiny new bow and realising you can't shoot it for buttons!

### **2.1 Bows**

The modern recurve bow is a stunning piece of technological achievement. The lightness and strength of the riser, the accuracy of the limbs, the hi-tech materials used to make the strings all make for a lean-mean shooting machine. This section is designed to give some insight into what these materials are, and what they mean to the average archer.

## 2.1.1 Technical terms for beginners.

For the novice archer, perhaps a summary of the terms used is useful here:

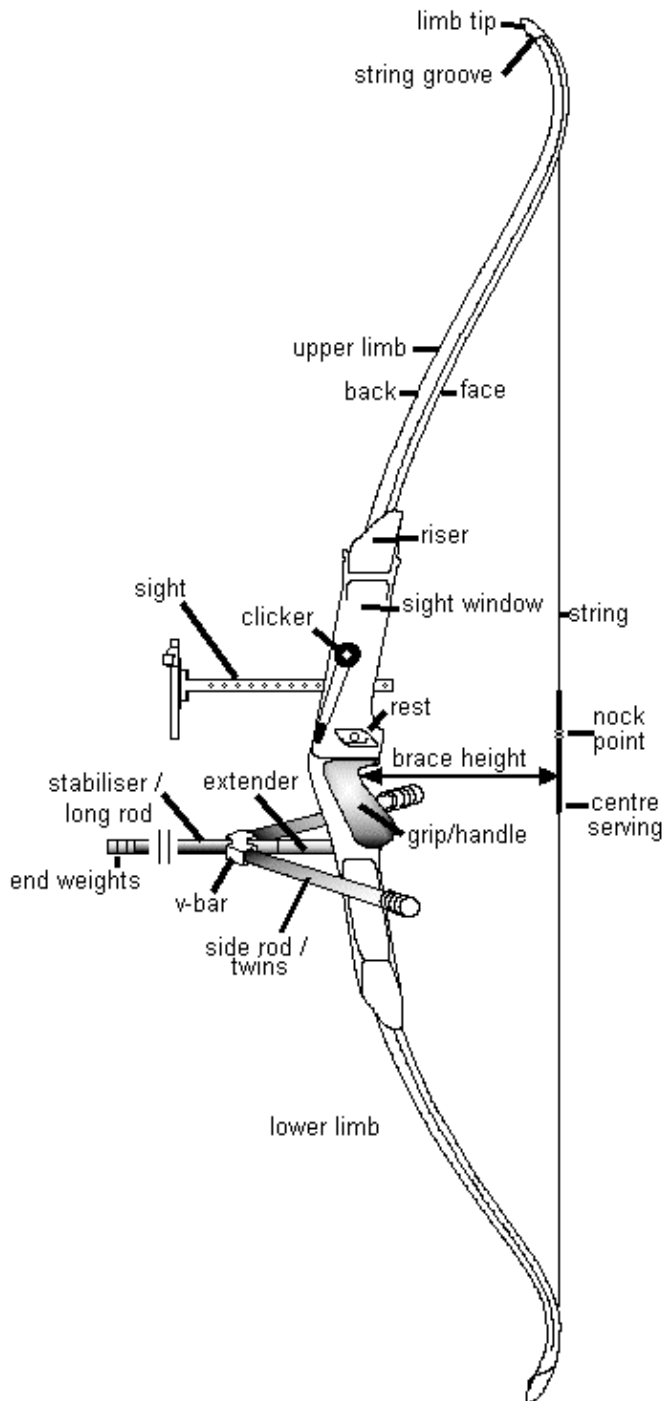

Many basic recurve bows are made from laminated timber usually with a clear finish on the riser and the limbs having a layer of fibreglass applied each side for strength. The types of timber used in the riser can vary, giving a multi-coloured appearance. The bow shown in the picture on the left is a one-piece bow. There is another (more common) type called a "Take-Down Recurve" which has a pocket at the top and bottom of the riser for the limbs to bolt into. This type of bow can be dismantled for ease of transport. The limbs, being separate, can be replaced by limbs that may be slightly stronger or lighter

The draw weight of the bow is usually written on the face of the lower limb. The weight is noted in pounds (lbs) at a draw length of 710mm (28 inches), e.g. #20 @ 28. Which means at a full draw of 28 inches the force required to hold the bowstring at this length will be 20 pounds (approx. 9 kilograms). This 28 inches (as defined by the A.M.O. standard) is measured as 26.25 inches from the nock slot to the throat of the grip (usually corresponds to the position of the arrow rest) + 1.75 inches.

A VERY simple way to determine an approximate draw weight is to add or subtract 2 lbs for each inch more or less respectively (for more than 40 lbs add or subtract 3 lbs).

A recommended draw weight for beginners would be between 15-20 lbs. for children and between 20-25 lbs. for adults.

At competitive level, women can average a draw weight from about 28 lbs to 38 lbs, men can average from 35 lbs to 45 lbs, typically. Draw weights have decreased over the years as the performance of materials used in the manufacture of bows, arrows and strings have improved.

### 2.1.2 Selecting the correct bow length

Recurve bows range in length from 48 inches to 72 inches. Most target bows will average 66 or 68 inches in length.

As a rough guide to choosing the length of a bow to suit you:

<b>Draw Length</b>	<b>Bow Length</b>
Up to 27" Draw length	64"
24-29"	66"
27-31"	68"
29" or over	70"

Further complications arise in that these lengths can be made up of various combinations of riser and limb lengths, for example:

	<b>Short</b>	<b>Med.</b>	<b>Long</b>
Short Riser (23")	64"	66"	68"
Long Riser (25")	66"	68"	70"

And just to confuse matters further, Yamaha, Sky, Martin and other manufacturers also make 24" and 26" risers.

So – what's the difference? If I have a choice, should I go for a long riser with short limbs, or a short riser with long limbs? Opinions are mixed, and as always the advice here is to try as many as you can get your hands on, but to give you some rough guide:

Long handle, short limbs = Faster, more tendency to stacking, less stable.  
Short handle, long limbs = Slower, more stable, less stacking.

Word of warning, however, some short risers can be difficult for people with long faces to shoot, simply because the pin can disappear behind the riser when shooting at short distances... let the buyer beware! As always, try before you buy.

### 2.1.3 Risers

The riser is the "heart" of the bow. Until approximately 30 years ago, most risers were made out of wood, often combinations of different types of wood, but the advent of modern materials (carbon arrows, Fast Flight strings) has meant that wooden risers could no longer cope with the strain placed upon them and the development of the metal-handled riser has been on-going ever since. Wooden risers are still fine for the beginner or "leisure" archer and many good scores have been shot using them, indoors and outdoors, but the competitive archer must look at the metal alternatives in order stay competitive. For target shooting at the top levels, you need enough arrow speed to give good sight marks, and little or no string creep, since many arrows are shot each day. This usually means using lightweight carbon arrows and strings made from Fast Flight or other modern materials, which impose large loads on the limbs and riser. Most wooden riser bows and most one-piece bows cannot take the loads from this equipment, and will almost certainly break eventually. There is also the issue of climactic variation, for example, wooden handle bows might have problems with variations in humidity which can affect the glues used to laminate them.

The majority of modern recurve (Olympic) bows are CNC machined. In years gone by, other methods were used to produce the riser:

### 2.1.3.1 Casting

Risers are typically cast using one of two methods: die-casting, and sand-casting. The casting alloy for both methods typically uses a mix of aluminium and magnesium.

Die-cast risers were once the primary riser in the market and are still important today, especially in low to middle-of-the-range bows. Die-cast risers are cheap to make (relatively speaking), but the mould itself can cost several hundred thousand pounds.

Cast risers have been known to break due to hidden flaws such as air bubbles or uneven dispersal of the component materials. For this reason, they are often designed to withstand over a thousand dry fires (release without an arrow). **DO NOT** try this at home!

Bows with cast risers available today include: Hoyt Gold Medallist, Yamaha Eolla, and the Samick Agulla (a fairly recent Korean Eolla-lookalike)

### 2.1.3.2 Forging

Forged risers have been available for many years. The riser begins life as a bar of material which is placed in a die and then hammered under high temperature and pressure into the die shape. This process results in a very strong riser, but which requires much machining and straightening before it can be sold. Forged-riser bows include the excellent Yamaha "Superfeel Forged". Most forged parts are painted rather than anodised, since this produces a better finish.

Forging is an expensive process and thus there are often fewer variations of forged risers.

### 2.1.3.3 CNC Machining

Hand-machined risers were being manufactured in small quantities in the 1960s, but the process is extremely expensive these days. Modern CNC machines which became available in the late 1980s provided the ability to mass-produce risers at a much lower cost and higher quality.

The first new CNC machined risers came onto the market in the early 1990s from companies such as Stylist and Spigarelli, however it was the large American compound bow manufacturers who ensured the success of this technology. Prices were as much as twice that of a cast riser due to the investment required in machinery and the higher material costs. (e.g. a Hoyt Avalon Plus or Elan, a PSE Zone, or a Stylist are machined from a solid billet of high-quality, stress-relieved aircraft grade aluminium alloy weighing more than 20 pounds, finishing up as a riser weighing less than 3 pounds. The result is a large amount of expensive waste)

In order to reduce the costs, risers can be extruded (pushed using extreme force) through a die to minimise the amount of machining required, but like the forging process, this results in metal which requires much straightening due to the pressures involved. (The PSE Universal is made using this process).

A well-designed machined riser on a recurve bow can, in general, withstand thousands of dry fires due to the high quality of the material. Again, DO NOT try this at home! Stories of Avalons cracking are well founded, but are simply due to the minimalist approach used to reduce the weight of the riser. The cracks are related to the machined holes and are not related in any way to a weakness in the process used.

CNC risers can be anodised – this provides a hard wearing finish.

### 2.1.3.4 Tomorrow's World

Original bow risers were made from a composite of materials such as wood, horn, sinew, fish glue etc. The future lies in "Advanced Composites". The principle is the same, but the materials are the modern equivalents e.g. carbon fibre, Spectra, Kevlar, and so on.

Several composite risers have been made on a small scale by several manufacturers and there are two primary methods involved: Hand lay-up of carbon "Prepreg" and Resin Transfer Moulding.

Prepreg is carbon, Kevlar and/or other materials mixed with partly cured epoxy. Hand lay-up is an expensive manufacturing process which provides an almost infinite number of possibilities in terms of



strength and flexibility, depending on the materials used, but bows made this way are expensive to design and test.

RTM or Resin Transfer Moulding comprises, in one method, of a dense foam core over which a “sock” of fibre is stretched. The whole structure is then placed in a mould, into which thermoplastic resin is poured under pressure. This is then cured to produce the completed part.

Risers made using this method as seriously expensive (Yamaha's Centennial (~1989), cost more than £1,500, but it did include a gold-plated clicker!) Others suffer from problems resulting from vibration problems or poor grips. The archery world awaits the future with bated breath (and no doubt, cheque books at the ready!)

#### **2.1.4 Limbs**

No - not the archer's limbs – the BOW limbs! The limbs are arguably THE most critical parts of the bow. Ultimately it is the movement of the limbs which imparts movement to the arrow. Any twisting, or variation between limbs during that process and it will be very difficult to put the arrows in the 10-ring. Good limbs are very forgiving of a poor release and feel smooth to draw. Poor limbs will punish a mediocre release.

The draw weight printed on the limbs is usually the draw weight at a draw length of 26.25" to the pivot point (i.e. the deepest point in the grip) or the draw weight at a length of 28" to the back of the riser. Unfortunately, on some bows this is 28" to the button... be careful when buying a bow that you know how this is measured.

In order to calculate, roughly, your draw weight from the marked weight on the limbs, take your draw length, measured from the nock to the throat of the grip in inches, then apply the following calculation:

$$\text{Actual\_weight} = \text{marked\_weight} - ((28 - \text{draw\_length}) \times ((\text{marked\_weight} / 20) \times 1.5))$$

e.g. If your draw length was 27 inches, and the limb was marked 38lbs then the actual weight would be:

$$38 - ((28-27) \times ((38 / 20) \times 1.5)) = 35.15$$

Note that this takes no account of the fact that poorly made limbs will “stack”, this means that the increase in weight becomes non-linear, i.e. a small increase in draw length produces a proportionally larger increase in draw weight.

##### **2.1.4.1 Materials**

There are three main types of limb on the market at this point in time:

- Laminated wood and fibreglass (all manufacturers)
- Laminated wood and fibreglass and some carbon fibre layers (many manufacturers)
- Carbon fibres and a core made out of some hard foam (e.g. "Syntactic Foam" in the "Carbon Plus" limbs from Hoyt) or ceramics (e.g. in the "Ceramics Carbon" limbs by Yamaha)

Wood/glass limbs perform well in areas where the temperature and humidity stay constant, however, wood is prone to stretching and warping when heat and humidity vary significantly. Carbon fibre layers help strengthen the limb and reduce the tendency to twisting. Modern carbon/foam limbs are highly impervious to climatic changes, and are therefore the most consistent. Newer techniques for forming the carbon core (e.g. as used in the Border XP10 Evolution and Hoyt FX limbs) are reported to provide even more consistent limbs resisting twist to a high degree, especially at the limb tips where they are weakest – the manufacturers claim that this provides a more forgiving limb.

### 2.1.4.2 Limb alignment

Limb alignment is a mechanism used to compensate for slight twists in the riser (see riser section for reasons why they may be twisted). Traditionally, take-down recurve bow limbs sit in a limb pocket and lock into place. Limb alignment adjustment provides the facility to adjust the pocket/limb relationship. This can cause problems if (say) the limb adjustment is of a poor design, resulting in an unreliable bow. If possible, avoid limb alignment pockets and simply insist on a riser which is perfectly straight.

In order to determine if your limbs are correctly aligned, fit a long-rod to the bow, rest the bow over the back of a chair or similar, ensuring that there is no weight or pressure on the limbs, and stand back from the bow, looking through one eye. The string should align as shown:

If you have difficulty finding the centre of the riser, attach a piece of masking tape to both limbs and measure and mark the centre of the tape with a dark broad line.

### 2.1.4.3 Limb weight adjustment

In order to provide some flexibility, most modern risers provide the facility to adjust the draw weight by tilting the point at which the limbs sit in the limb pockets. On some bows, this means adding packers to the bottom of the limb pockets to reduce the weight, on others the limbs are adjusted by means of an adjustment screw at the back of the limb pocket. In most cases this will only provide up to 4lbs (up to 10%) of adjustment.

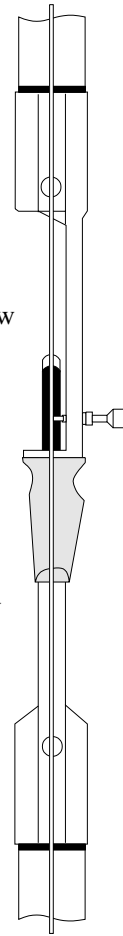

## 2.1.5 Strings

A string is a string isn't it?

Well, no. Just as there is a myriad of materials for arrows, limbs, risers, etc... modern string materials provide a similarly confusing picture!

### 2.1.5.1 Technical terms for beginners.

The string has four main components:

The string itself – usually made from a single strand of material (this is often referred to as an endless loop).

The loops – these fit over the ends of the bow limbs. The top loop is usually larger than the bottom loop to enable it to slide down the bow limb prior to stringing the bow.

The centre serving – the extra thread wrapped around the centre of the string where your fingers are placed before drawing the bow.

The nocking point – the position at which the arrow is clipped to the string. To stop the arrow moving up and down the centre serving, loops of material (dental floss is commonly used) are tied around the serving above and below (some archers use only one) the position for the arrow. Cyano-acrylate (Super-glue) is then added to these knots to make them hard-wearing and to prevent them from coming loose. Nocking points can also be made from masking tape, similarly soaked in super-glue, clamp-on metal nocks and plastic nocks which must be served into the finger serving (Beiter use this method).

### 2.1.5.2 Materials

#### **Dacron**

This polyester was developed in the late 50s/early 60s by Dupont and is still in use today. Dacron is long-lasting and it is slow. The slow speed is due to the excessive stretch on each shot. The stretching process removes energy which would otherwise be used to propel the arrow. The stretching does have the advantage that it is kinder to the bow limbs and riser and therefore is ideal for bows with wooden risers or limbs, or even some of the older cast risers.

This material doesn't like friction, so a low number of twists is required. Newer versions such as B75 Dacron and PENN 66 are available, but these have few benefits.

### **Aramid Fibres (Kevlar)**

These "Liquid Crystal Polymers" are very strong and were first used in the mid 70s. By the early 80s most top target archers were using Kevlar (or Technora). These fibres are strong due to the uni-directional nature of the molecules, but had a tendency to shear easily resulting in frequently broken strings (usually just below the nocking point). Some of these strings lasted as few as 1000 shots. Kevlar is also susceptible to moisture and so must be waxed carefully. LCPs are still around today in the form of Vectran. Vectran has no creep (at normal bow weights), but is slower than Dyneema or Spectra and has a tendency to snap like Kevlar, so should not be used on its own.

### **High Modulus Polyethelene (HMPE) fibres (Spectra/Dyneema)**

The ultra long chain polyethylene fibre strings popular today were originally developed in the mid 80s and the material quickly proved to be far superior to Kevlar. Brownell & Company made modern-day history by introducing Fast Flight material, made from Spectra fibre. Spectra fibre is VERY long lasting. It has been known to last more than 100,000 shots and is not susceptible to moisture and can be twisted as much as required. These are also the lightest and fastest of the materials available.

"Dyneema" and "Spectra" are similar material in that they are both made from a "gel-spin" process, in which the constituent material (polyethylene) is dissolved in solvent and spun through a small orifice.

There are a number of new brand names on the market:

### **Angel Dyneema**

Angel ASB (Angel Special Bowstring) Dyneema is made in Japan. It is Dyneema material which has essentially no wax. Angel Dyneema is the choice of many top archers because of its quality, consistency and smooth-feeling shooting characteristics. It is also a little lighter than an equivalent string made from other materials because it has no wax (even though the label says it is waxed).

### **Dynaflight**

The original BCY Dynaflight was made from Dyneema and was comparable to Brownell Fast Flight Spectra material. The current BCY "Dynaflight 97" from Dyneema was originally developed for marine rope applications.

A 14 strand Dynaflight 97 string is just slightly smaller in diameter than a 20 strand Angel Dyneema string, but it is about 33% stronger and has 20% higher modulus. The material is very stable and comes with a light wax content.

BCY 450 Plus. This material is 66% SK75 (the material used in Dynaflight 97) and the rest is Vectran. This kind of material is best suited for the compound bow, where creep is an issue for buss cables. 12 strands of this material are equivalent in diameter to 20 strands of Angel Dyneema or 18 strands of Fast Flight. Latest product of this Dyneema/Vectran mix is BCY 452 which is half the diameter of 450+.

8125 is one of the latest Dyneema products on the market and is faster than Dynaflight 97 (due to a smaller diameter). Typical strings are 18-20 strands.

### **Fast Flight**

Made from Spectra, this is the bowstring of choice for a large percentage of the archery population. Easy to use, lasts almost indefinitely, has a little stretch (but is therefore kinder to equipment). This often comes heavily waxed and the first job is often to remove some of the wax to prevent wax loss during shooting from affecting the tune too much.

### **Fast Flight 2000**

Introduced in 1998, Fast Flight 2000 is Brownell's answer to Angel Dyneema and BCY Dynaflight 97. It is 30% stronger than Fast Flight, a little larger in diameter, and comes with a medium wax content. It should be very comparable to Dynaflight 97. About 14 strands of this material should make a string equivalent to an 18 strand Fast Flight string diameter.

### **Strength/Stretch Comparison**

Dacron B50 - (strength per strand = 22.5 kg. , stretch = 2.6%)

Kevlar 7-11 - (strength per strand = 31.8 kg. , stretch = 0.8%)

Fast Flight - (strength per strand = 45.5 kg. , stretch = 1.0%)  
Fast Flight S4 - (strength per strand = 73 kg. , stretch = less than 1.0%)

Other materials, for which I have no stretch data are:

Fastflight 2000 – (strength per strand = 61 kg)  
Angel Dyneema – (strength per strand = 49.9 kg)  
Dynaflight 97 – (strength per strand = 54 kg)  
BCY450+ - (strength per strand = 68 kg )  
BCY452 – (strength per strand = 32 kg )  
BCY8125 – (strength per strand = 45 kg)

### 2.1.5.3 So what should I use ?

As you can see above there are lots of choices. A few guidelines may help you decide what you might want to use.

For the average archer (with a suitable bow), Fast Flight is common, easy to get a hold of, well proven, reliable – everything you could want in a string material. For the advanced archer, the other materials can provide very definite advantages in shot feel and consistency:

Angel Dyneema makes for a softer feeling shot and a good-sounding bow. Colour is limited to white. No wax content means the string stays very consistent but needs some care.

Dynaflight 97 is very easy to work with because it is easier to make a 14 strand string with equal tension on each strand than a 20- strand string. “Just the right amount” of wax means this string is low-maintenance and won’t change much over time. It does need a few more twists to make it as pleasant sounding as Angel Dyneema. It’s soft to shoot like Dyneema but as fast, or faster than Fast flight.

Fast Flight 2000 is also easy to work with. Heavier wax content means it is easy to make strings on automatic machines but you need to remove some of the wax if you make the string yourself or you will have a string that loses weight over the first few weeks of use.

Brownell’s Fast flight S4 is another blend of Vectran and Spectra (twisted together). This is high performance stuff and has very little stretch. The string will stretch about 1/16” to 1/8” in the first dozen arrows, then will exhibit no more stretch. Performance may be slightly slower than Fast Flight for the equivalent thickness of string due to the use of the heavier Vectran material. Due to the increased strand size an archer used to 18 strand FF will have to shoot a fatter (10 strand) or thinner (9 strand) string. Fewer strands also make for easier string making. Disadvantages? Some archers have found that performance deteriorates after initially improving groups. S4 must be kept lightly waxed, after a few thousand shots the wax wears off and performance deteriorates, gentle waxing seems to restore good grouping! Colours black and natural.

**And remember, as reliable as these materials have become, always carry a shot-in back-up string!!**

### 2.1.5.4 String Length

Length of the string will determine the bracing height.

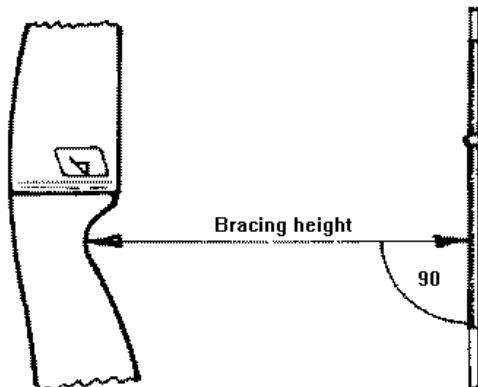

Bracing Height is measured from the pressure button to the bowstring at 90 degrees. Most bows will have a recommended brace height given by the manufacturer.

If the brace height is not known, then a rough guide for recurves is:-

70 inch bow = 8.50 to 9.75 inches,

68 inch bow = 8.25 to 9.50 inches,

66 inch bow = 8.00 to 9.25 inches.

64 inch bow = 7.75 to 9.00 inches.

The ideal brace height for a bow is one that produces the quietest release with the least amount of vibration in the bow.

To give some guidance, on my bow a 64.5" string will give a 6.75" bracing height (too

long!), a 62.75" string will give a 9.25" bracing height (too short!!), and a 63" string will give a bracing height of 8.75" (Just right! – for my bow). I have found that 4 or 5 twists can make as much as 1/8" difference in the bracing height.

In order to increase or reduce the bracing height by small amounts, twists can be added or removed from the bowstring respectively, but a string of approximately the right length must be used in the first instance. If you have no means of establishing the correct length of string, measure around the back of the bow from tip to tip, following the curves of the unstrung bow, then take 90 mm from that length as an estimate of length.

### 2.1.5.5 Number of Strands

Always use the manufacturer's recommended number of strands in the bowstring for the draw weight of the bow. Using too few strands can over-stress the bow limbs and possibly break them.

For Dacron B66, typical numbers of strands are : 20 – 30lbs:8 strands. 25 – 35lbs:10 strands. 35 – 45lbs:12 strands.

For Fast Flight: There is some initial stretch in Fast flight but that should settle in less than 500 shots.

Typical archers will use 16 or 18 strands but some archers prefer as little as 12 or as much as 22.

For Angel Dyneema, a typical archer will shoot 18-22 strands.

For Angel Dyneema Sensitive, a typical archer will shoot around 16 to 20 strands as it is slightly thicker than ASB.

For Dynaflyte and Dynaflyte '97 a typical archer will shoot around a 14-16 strand string.

A larger number of strands will provide stability and be more forgiving, but will be slower.

### 2.1.5.6 Number of twists

The first factor in deciding the number of twists to put into a string depends on the material – for Dacron, fewer twists are recommended as the strands rubbing together could cause damage. For Fast flight, however, there is no limit.

The strands of a twisted string will come apart (balloon) less after the release. Typically the string is given between 20 and 40 full twists – this varies depending on the required brace height. Obviously, the archers who make their own strings have an advantage here in that they can easily experiment with different string lengths vs. number of twists.

Tip: ALWAYS check your bracing height after stringing your bow, and again after the first dozen or so shots. One of the top UK archers said that as much as a 1/4" difference in bracing height can lose him up to 20 points on a Portsmouth.



Start winding the string around the posts, first to post 1 then on around the jig in the direction shown by the arrows. Take care to keep the tension the same on all turns, and try to keep the spool of material at the same angle to the jig all the way round so as not to twist the individual strands. Wind on the number of turns to half the desired strands needed in the string, i.e. if a 20 strand string is required wind on 10 turns. When the desired number of strands have been wound on, tie the end of the string material to post1, keeping the tension on the final strand the same as all the others. Loosen the wing nuts on the sliding end a little, waggle the end and pull up as tight as possible to get the tension even on all the strands, then re tighten the wing nuts. You are now ready to serve the loops.

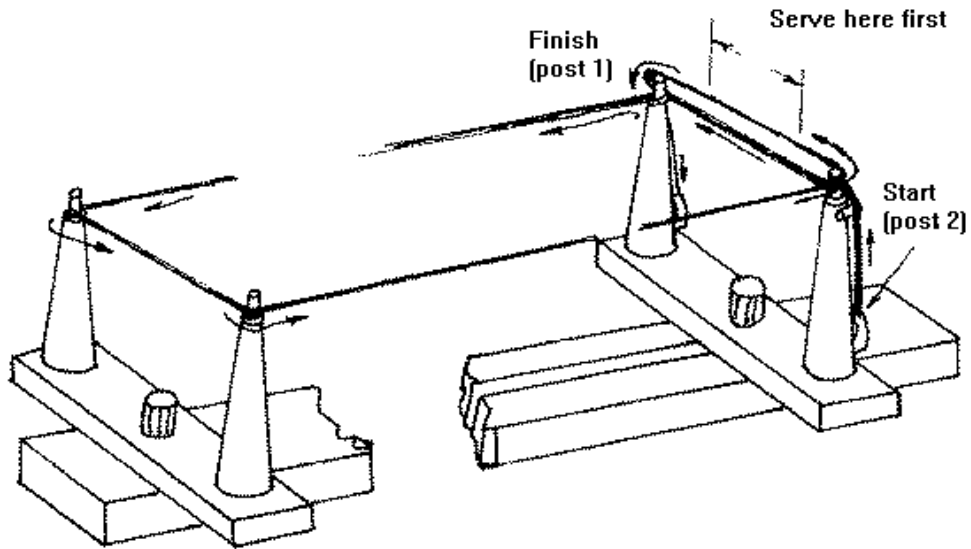

#### 2.1.5.7.3 Starting the servings

The servings are started by taking the serving material already loaded into the serving jig and laying the end of the serving material pointing towards post 1 then winding over the top of this strand towards post 1 as shown in the drawing below. When 10 to 12 mm of serving for shank, and 4 to 6mm for loop, has been wound on the end of the serving can be pulled tight and the serving continued with the end of the serving outside the serving.

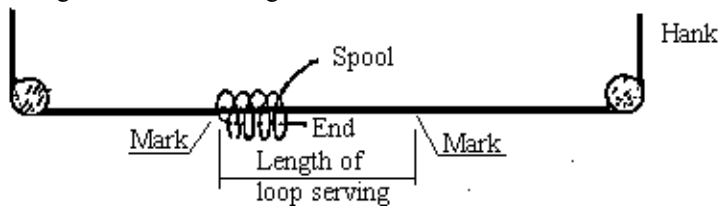

The loose end can be cut off later with a sharp "Stanley Knife" or razor blade as close as possible to the serving. The end is locked in by itself in this way, a little glue can be put on the end as added security if desired.

#### 2.1.5.7.4 Ending the servings

The servings are ended in a way that is similar to the start of the servings. To achieve this about 10 to 12mm from where the serving is to be ended (4 to 6mm for loop servings) pull a loop off the serving tool then a little way up the string start to serve back in the opposite direction, passing the serving tool through the loop until you have it as shown below, "B" being the serving and "C" being the reverse serving. If you have wound the reverse serving in the right direction you will be able to continue "B" by unwinding "C" and winding over the end of the serving material E.

When all the turns of "C" have been used up simply pull "E" to pull the remaining loop into the serving and lock the end tight. **NOTE** that due to the twisting action of the serving, this loop may twist and pull into a knot. To avoid this, put a pencil in the loop to help keep tension on the serving material.

The loose end can be cut off with a sharp "Stanley Knife" or razor blade as close as possible to the serving. You will find that if scissors are used to trim off the excess serving material they will not trim it as closely as a sharp blade and will always leave 1 or 2mm outside the serving. An alternative method is to cut the serving 1-2 cm from the whipping, and melt the end down using a flame, but remember to douse the end with a wet finger before it burns down too far!

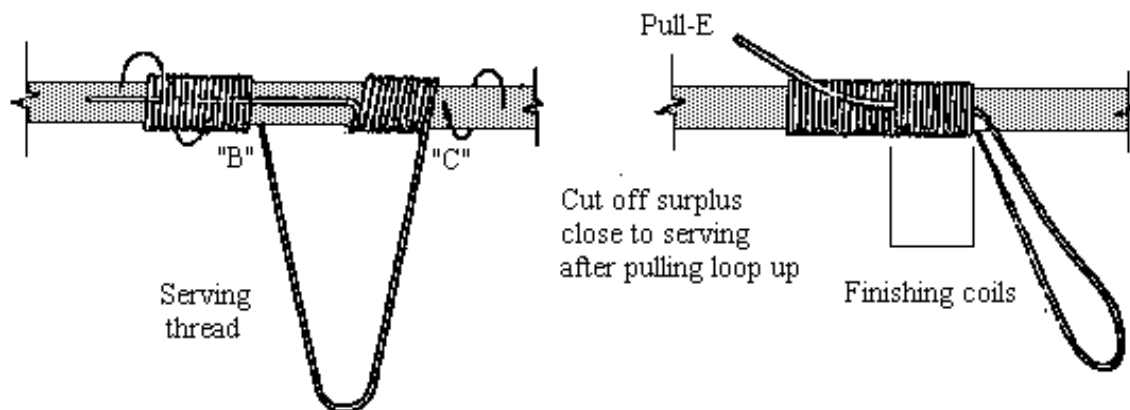

Length of starting and finishing coils 6mm for loop serving and 10 to 12mm for upper and lower shanks and for finger servings

#### 2.1.5.7.5 Serving the loops

Check the limb tip to determine how big the loop is to be, don't forget that the upper loop will have to be large enough for the loop to slide down the limb when stringing the bow and this will determine the size of the top loop. However don't make the loop so large that the bow unstrings itself when shot!!!. The lower loop is generally smaller than the top loop as it does not have to slide down the limb when stringing the bow.

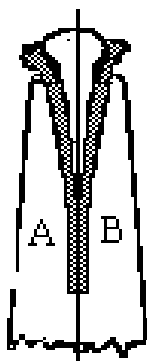

Serve the length of the loop from "A" to "B". Starting and ending the serving as shown previously. This will secure the two ends of the string which are currently tied to posts 1 and 2. The excess string material can now be trimmed off level with the ends of the serving. The serving is sufficient to hold these ends in place.

They should not be tied with a knot as the knot will always appear through the serving, neither should the ends be left long enough to go into the shank serving as they will not be even under the serving and this unevenness may twist bow limbs.



Now turn the posts at this end in line with the string jig and position the string as shown.

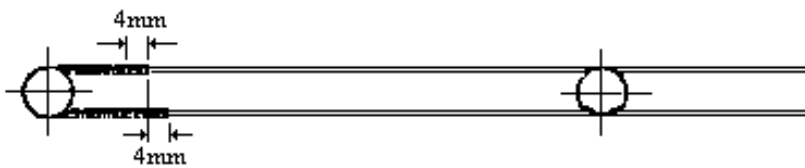
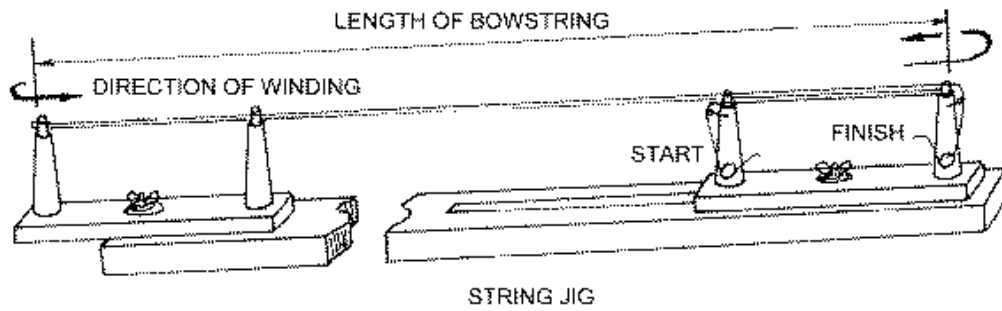

The shank serving can now be wound using the techniques previously described to complete the first end of the string.

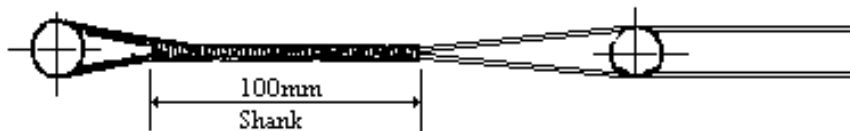

The same technique can now be used to serve the other loop. When both the loops are formed make sure the string is well waxed and fit it to the bow to check the bracing height, then unstring the bow and put in the number of twists to achieve the correct bracing height. If the correct bracing height cannot be achieved another string has to be made using the knowledge gained to determine the correct length.

With the string on the bow the centre, finger, serving can be put on. Measure the position of the nocking point, and serve from 40mm above that point to 75mm below. **NOTE that the string is twisted BEFORE serving the centre serving – this is to ensure that the string twists are uniform along the length of the string.**

Too long a serving will add weight to the string and make the bow lose arrow speed and distance, unless it is desired to add stability to the set up.

#### 2.1.5.7.6 The nocking point

The nocking point can now be added to the string, using the previous string as a pattern. If the nocking point height is unknown start at between 3 and 10mm above horizontal and determine the nocking point in the usual way (see tuning section). To make the nocking points, tie or lash loops of material (dental floss is commonly used) around the serving above and below the arrow position. (some archers use only one nocking point above the arrow) Adding Cyano-acrylate (Super-glue) to these knots will make them last longer.

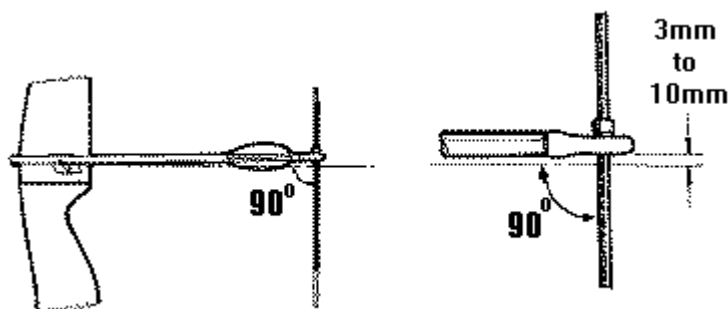

Nocking points can also be made from masking tape, similarly soaked in super-glue, or metal nocks may be added and “crimped” onto the string using pliers. Many top archers use plastic nocking points manufactured by Beiter, from Germany – these can

be difficult to serve on to begin with, but with a little practice will become easier.

#### **To serve a Beiter Nocking Point:**

The Nocking-Point is made out of two identical halves, which must be served into the serving, paying attention to fit pins and holes. Tools that you need:

- String server with the desired serving material
- Beiter Nocking Point (2 halves)
- Gauge,
- Marker

**Important** Use a proper, not too stiff serving material. The Nocking Point must be served tight, but not too “tight”. If it is served too “tight”, the Nocking Point will be the only real elastic or giving part on the string: the consequence can be, that it will bend and eventually crack. Important If the Nocking Point cracks after a few shots, it is a sign, that you used a wrong serving material or that you served to “tight”!

- String the bow, find the desired nocking point with the gauge and mark the correct position with the marker.
- Place half the nocking point on the string and mark the position of all four “shoulders”.
- Attach the other half of the nocking point to the first half (paying attention to match the holes and pins).
- Fasten the free end of the serving to the string and serve four or five long turns to feed the material into the nocking point at a flat angle.
- Wrap the serving around the nocking point tightly, but not with excessive tension.
- When you reach the inner shoulder of the nocking point, the serving should change direction and serve back down towards the end of the nocking point.
- Serve back down on to the string a few turns, then ensure that the nocking point is correctly positioned before continuing.
- Serve another half an inch over the free end of the serving, then cut off the free end of the serving.
- Finish the serving as normal.
- Repeat on the other side of the nocking point.

More details, and pictures, can be found on the Beiter web site.

#### 2.1.5.7.7 Serving materials

MONOFILAMENT	Clear coloured nylon, looks like fishing line. Used for centre serving on Dacron strings, never loop servings. After serving heat slightly to set into shape with match or lighter. Very often used by barebow archers to count the number of turns to set finger placement for various distances.
SOFT TWIST	Can be used with all string materials for all servings.
ANGEL	Very expensive, said never to wear out.

#### 2.1.5.8 Maintenance

For waxed strings, simply apply more wax now and again. Burnish the wax with a leather cloth to melt the wax into the material. Be careful not to generate TOO much heat, or you may melt the string material. Waxing doesn't just keep the rain out of the string, it has other purposes:

- Lubricates the fibres to prevent fibre/fibre abrasion
- Helps keep fibres together to prevent the strands "ballooning out" and slowing the string down.

When maintaining a string, a good quality silicone wax is recommended as it penetrates the fibres better, and can also penetrate the serving.

Check regularly for loose strands or fraying. If in doubt, get rid of the string.

Check serving. If the serving is looking loose, repair it as soon as possible.

When using a new string, this should be "shot-in" with a couple of hundred arrows or so.

Always make sure you have one or preferably two spare "shot-in" strings with you at competition.

### 2.1.6 Buying a bow

#### 2.1.6.1 Cost

A good second-hand bow suitable for competition will cost in the region of £200-£400 (1999 prices), depending on condition. Added to this is the cost of arrows and other accessories (sights, stabilisers, bow case, bow stand, etc.). It is, of course, possible to buy just the bow with string and sight, a limited number of arrows and add the accessories at a later date.

#### 2.1.6.2 What to look for?

Well, many of the bow components have been described in great detail in the previous sections. In most cases a good second hand bow is better for beginners than a brand new bow – this is mainly down to cost. Archers are far too concerned about the look and the age of equipment. How it FEELS is much more important.

An archer (Stan Siatkowski ) posted an anecdote that he shot next to Vladimir Esheev (USSR) at the 1987 World FITA Target Champs in Adelaide when he won the Grand FITA, and also had the highest FITA round. He was shooting a ratty old Hoyt TD3, chipped blue paint, frayed string, and the bottom limb was so twisted, the string lay about 1/4" out of line.

I wouldn't advise ANYONE to shoot with a frayed string, but the sentiment is of course spot on. The equipment we buy doesn't have to be the latest and greatest – it just has to be CONSISTENT, and it has to feel good to the owner. No more, no less.

##### 2.1.6.2.1 Try before you buy

The catchphrase to remember! Try as many bows as you can get your hands on. Every bow shoots and feels a little different, so it's important to find one that fits you and your style. Looks can be important – but only psychologically. If you're the kind of person who needs to be seen to be up to date and "trendy", then buy the latest bow... it'll cost you, but that old Yamaha Eolla or Stylist Star might never suit your needs, however, if you don't care as long as it shoots well, then go for what fits you.

##### 2.1.6.2.2 Bow style

Buy a bow which you can grow into. A Hoyt Gold Medallist can be bought very reasonably second-hand (or even brand new), and no one can argue with its pedigree or long line of successes. If you intend to shoot long distance (70-90m) make sure that whatever riser and limbs you get – they can withstand the pressure of Fast Flight strings and carbon arrows. If you're not sure, ask an experienced archer, or one of the many archery shops – they'll be happy to advise.

### 2.1.6.2.3 Limb weight

Don't get something that's too heavy. If you go for a riser which takes Hoyt standard limb fittings, then you can always trade up later. Buying something too heavy is guaranteed to mess up your scores, potentially injure you and generally make you miserable – it's not worth it. If you can't get 90 metres this year, then work out, exercise – build up those muscles THEN upgrade the bow. Meantime, stick to the Short Metrics or winning the indoor competitions!

## 2.2 Arrows

### 2.2.1 Technical terms for beginners

For the novice archer, perhaps a summary of the terms used is useful here:

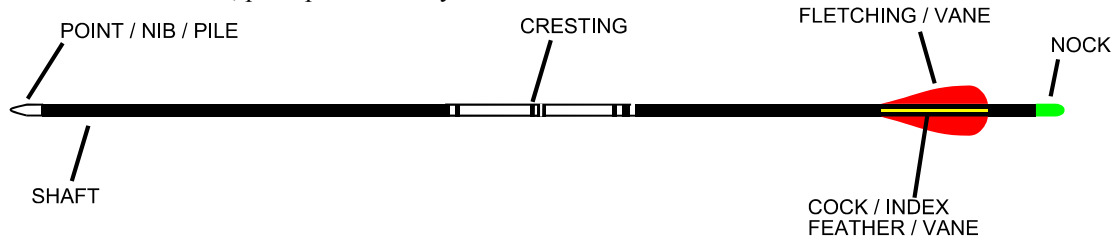

### 2.2.2 Material

#### 2.2.2.1 Glass fibre

Heavy shafts only used for training.

#### 2.2.2.2 Wooden

Mainly used for traditional archery.

#### 2.2.2.3 Aluminium

The most popular arrow choice for indoor shooting (see below). The arrow is formed from an extruded aluminium tube. Typically heavier than carbon shafts since the strength comes entirely from the thickness of the material. Aluminium shafts sizes are usually defined by a four-digit number. The first two digits represent the diameter of the shaft in 64ths of an inch. The second two digits represent the thickness of the material in thousands of an inch. E.g. 2013 which means the arrow is 20/64<sup>th</sup> inch (7.94mm) diameter and has a 13/1000<sup>th</sup> inch (0.33mm) thick wall

Aluminium arrows will bend, but it is possible to straighten them. They are typically half as expensive as carbon arrows. Aluminium arrows can also be easily cut to length.

#### 2.2.2.4 Carbon

Although there are “pure carbon” arrows available (e.g. the Beman Diva), arguably the most popular arrows of choice (Easton ACC/ACE) are formed from a combination of aluminium and carbon. This mixture provides the benefits of lightness with strength. The arrows have an inner aluminium core and an outer wrap of carbon fibre. Nocks can be either “inserts” or “outserts” (also called fit-over) depending on whether the nock is fitted inside the aluminium core, or on the outside of the carbon. Beiter now have an in-out nock for ACEs and X-10s which reputedly give the arrow better protection from rear-end impact – these are, as you would imagine, a combination of insert and outsert nocks.

The ACE and X10 shafts are sized by their “spine”, so an ACE 720 has a spine of 720 thousands of an inch at 29 inches. This refers to the amount the shaft will bend when suspended between two points, 28 inches apart and a 2lb weight is hung from the centre.

In the case of ACEs (and, more recently X10s), these arrows are also “barrelled”, i.e. they have a larger diameter at the centre than at the ends. This has 3 distinct advantages:

It is lighter than the equivalent parallel shaft  
It has a higher frequency of oscillation making it more efficient.

It has a lower surface area and therefore performs better in windy conditions

Carbon arrows, being lighter, are typically much faster out of the bow and therefore care must be taken to ensure that the bow is capable of shooting such a light arrow. Owners of older wooden limbs and some early metal risers should check with the manufacturers before using carbon arrows or some of the more modern string materials, such as fast-flight (see string section).

Carbon arrows have a tendency to shatter rather than bend, therefore hitting anything but the boss can be an expensive habit. Beginners are therefore encouraged to shoot aluminium arrows until they are confident of their abilities.

### 2.2.2.5 Indoor target archery

Pretty much anything which can be tuned can be shot indoors. Wooden arrows are generally avoided because of the lack of consistency and resilience.

Aluminium is the usual arrow of choice, with a few archers choosing to shoot carbon. The benefits of aluminium indoors are that, being generally much wider they increase the chance of line cutters (an arrow touching a line between two scores, counts as the higher value) – this could perhaps be worth an extra 2 or 3 points to the average archer.

### 2.2.2.6 Outdoor target archery

Carbon or aluminium/carbon mix is the usual arrow of choice for the long distances of outdoor shooting.

The lightness of the carbon arrow has the advantage that it will travel a greater distance than its heavier aluminium counterpart. The disadvantage is that since the arrow is lighter, it may be more prone to the effects of crosswinds (archers typically use spinning vanes with carbon arrows in an attempt to counteract this – see vanes section). Heavier points may also assist down-range stability at the expense of a loss of speed and therefore sightmark.

## 2.2.3 Choosing the correct length

To determine the correct length for you, draw the bow to a comfortable full-draw position and have someone mark the arrow approximately 1” beyond the button position. (beginners may want to add 1-1.5” to this in order to permit some development in muscles and technique). With modern lightweight arrows, there is no harm in shooting a slightly longer arrow.

### 2.2.3.1 Cutting Shafts

Cutting any shaft is usually done using a high-speed arrow saw using an abrasive disk – these have a rotation speed of 5000 rpm or more, and a 4” cutting disk.. This device ensures that the cut is square and does not splinter arrows, particularly those including a carbon-fibre component.

Barrelled shafts have the disadvantage that cutting one to length is only for the advanced archer. It is advisable that cuts on an A/C/E, for example are only done at the FRONT of the shaft. It is possible for accomplished archers to cut up to 1” off the back of the arrow, but consistency and squareness are VERY important, and cutting from the rear of the arrow will “stiffen” the arrow faster than cutting from the front, as well as affecting component (nock) fit.

### 2.2.3.2 Node points

The point at which the arrow rests against the button at full draw should ideally be one of the two “node” points, i.e. one of the two points of the arrow which do not move laterally during flight. This will tend to reduce the effect of a poor release as the node points of a shaft in flight tend to stay nearly still compared to the point of the shaft as illustrated below.

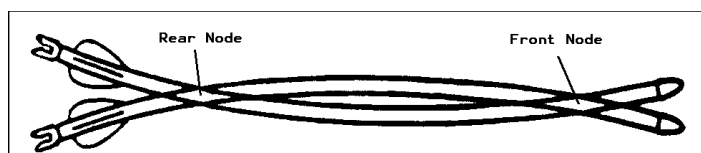

So how do we find these invisible magic node points? A bit like tuning a string. Dangle the arrow vertically between finger and thumb somewhere near the tip of the arrow and tap the lower end against a solid object. Note the length of the vibration. Now move your hand down the shaft and try again. Repeat this process until you find the point of maximum duration. This is the front node point of the arrow. Easy!

## 2.2.4 Choosing the right arrow

The arrow will bend when shot – this is unavoidable, therefore the correct arrow “spine” must be selected to ensure that the arrow neither bends too much (whippy), nor too little (stiff). The spine of the arrow can be matched to the bow with some confidence with two pieces of information:

- The arrow length (note this is nothing to do with your draw length)
- The weight of the bow at your draw length – best to measure this with a bow scale.

Note that many bowscales are inaccurate! Especially the spring-types which can often be 3-5lbs out!

A longer arrow will act “whippier” than a short arrow of the same shaft diameter and thickness. A heavier bow will also cause the arrow to act “whippier” than a lighter bow.

Given these two pieces of information, the preferred shaft size can be looked up in any of the many shaft selector charts which are available from the manufacturers and distributors. For a more accurate picture, some other information is required:

1. Whether the archer shoots “fingers”, or a release aid is used.
2. Whether the string is Fast Flight (or similar material) or Dacron.
3. Whether the point is heavier or lighter than the recommended point weight (A heavier point will cause the arrow to act whippier).

Again, the shaft selection charts will provide guidance here. If you can, beg/steal/borrow arrows which are the spine you think you need! Many archers waste lots of money by simply making the wrong choices on arrow spine. Arrow selection can be a long and tedious process for some, and simplicity itself for others.

## 2.2.5 Points

Points come in many different weights, depending on the wishes of the archer. It is best to start with the recommended point weight. Weight can be added/removed for micro-tuning (for the advanced archer only).

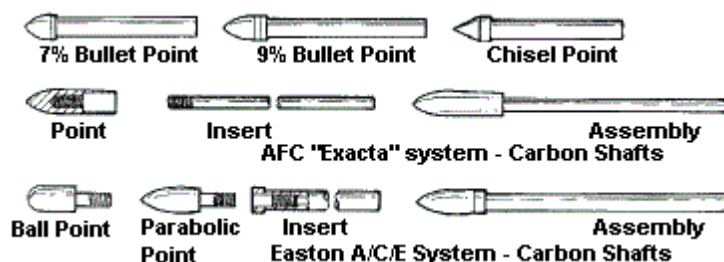

Points are simple to fit to aluminium arrows. Typically, archers use hot-melt glue. This is an adhesive which is supplied in solid sticks. Heating the glue causes it to melt, and it solidifies when cool.

The best approach is to heat the shaft of the point gently until hot enough to melt the glue (hold onto the point while doing this – if it becomes too hot to hold, then the shaft is too hot also). Apply the glue to the shaft of the point, then push firmly into the arrow shaft, twisting it to spread the glue. If the glue sets too quickly, simply apply more heat to the point to re-melt the glue.

**CAUTION:** Carbon does not like heat, and therefore great care is required when fitting points to carbon arrows. Only use sufficient heat to melt the glue, no more. And do not apply direct heat to the carbon shaft.

To remove points, carefully apply heat to the point and arrow shaft, just enough to melt the glue, then use pliers to pull the point out. Placing the arrows point-down in a cup of hot water is also a good method of loosening off a lot of points at once.

## 2.2.6 Fletchings or Vanes

Fletches or vanes are the steering mechanism of the arrow.

Indoors, archers typically use the largest vane. This has the advantage of ensuring that the arrow straightens up very quickly – important for the short distances shot indoors.

Outdoors, the large fletchings have the effect of slowing the arrow down too much, and therefore a small vane is the vane of choice. Spinwing™ vanes impart (surprise, surprise) a spinning motion to the arrow which provides greater stability, and a typical outdoor setup would be ACE arrows fitted with 1 3/4" spinwings.

Fletches are typically made from soft plastic in various shapes and sizes as shown.

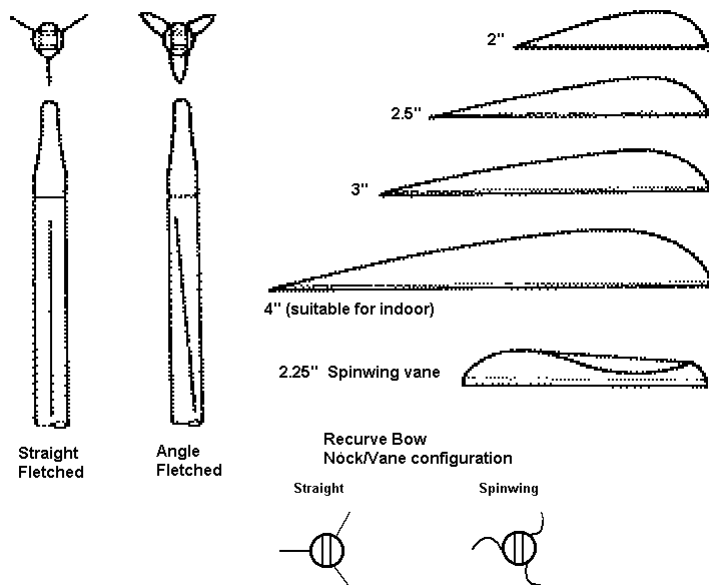

Be aware that spinwing vanes of different **colours** have different **stiffness**, therefore most archers use spinwings which are all the same colour. White is the softest, followed by blue and yellow, then red and black. It has also been shown that the stiffer vanes produce less drag.

Spinwings are typically much more fragile than straight vanes, but much easier to change during competition. They are also much lighter than vanes.

Feather fletches can be used, but are not as durable as the plastic fletches, and

perform poorly when wet. Some archers use large feathers when shooting indoors. Studies by Easton have shown that feathers not only start the arrow spinning earlier, but provide better grouping.

Usually three fletches are glued to the arrow shaft near the rear of the arrow. They are sometimes angled to make the arrow spin as it flies, to give a more stable, straighter flight. The orientation of the fletches in relation to the nock must suit the type of arrow rest used. The bottom diagrams show the rear view of the arrow suitable for a recurve finger shooter.

### 2.2.6.1 Adding fletches to aluminium arrows

Clean the rear end of the shafts where the fletches will be glued with 'Acetone' and at the same time, the shafts of the points can be cleaned to remove any loose oxide, oils or dirt. A spare set of nocks can then be twisted onto the rear end of the shafts. Nocks, such as the Bjorn nock, will 'stick' to the shafts rear end by means of the roughened surface.

I use a spare set of nocks, so that when they are placed into the fletching jig, I don't have to worry about the nocks opening up due to the jig's guides. The proper set of nocks can be glued on after the fletches are done.

Before gluing the fletches, use 'Acetone' to clean the base of the fletches. Take care to align each fletch in the same place on the shaft. A guide mark can be placed on the fletching jig clamp for reference. Use 'Fletch-Tite' glue on the fletches. Make sure the fletch rests evenly along its length onto the shaft when glued. This glue will set enough for the clamp to be removed after 3 minutes. If using a different coloured fletch for the 'Cock Fletch', then it's a good idea to glue these on first when using a multiple fletching jig, then glue the others on later. After the glue has set on the first fletch, rotate the nock



holder to its next position, usually 120 degrees for a 3 fletch setup. Repeat until all fletches are on. You can then apply an extra blob of glue to the front and rear of each fletch as this helps prevent the fletch tearing off when the arrow lands in the ground or passes through a soft target, and also helps prevent the front of the fletch lifting and so catching on the arrow rest.

### 2.2.6.2 Adding fletches to carbon arrows

The arrow shafts should only be cleaned with an abrasive cleaner, rinsed and let dry. Straight fletches are mounted using the same techniques as for aluminium arrows with the exception that 'Fletch-Tite' glue should not be used on carbon shafts. "Flex-Bond", or another glue that is compatible with carbon shafts should be used. Spinwing vanes are mounted as follows:

Using the fletching jig (or a special tool), mark three lines on the shaft with an indelible marker, 120 degrees apart, the length of the vane and at the required distance from the nock. NOTE: If you're using Bieter nocks either get the adapter for the fletching jig or change the nocks to a symmetrical nock while drawing the lines!

Put spinwings on straight, otherwise most people find the drag excessive. There is a natural angle in the vane so you don't need to induce extra drag.

The spinwings are supplied with two types of tape: the first (double sided) is used to mount the fletching on the shaft and can be used in one of two ways:

- Apply the tape to the shaft, then apply the vane to the tape. This is the preferred approach
- Apply the tape to the vane then apply the vane to the shaft using the clamp from a fletching jig.

When the vane is in position and well stuck down, use the second tape to "top and tail" the vane. This tape prevents the vane from lifting at either end and should be wrapped around the shaft and the ends of the vanes a couple of turns.

### 2.2.7 Nocks

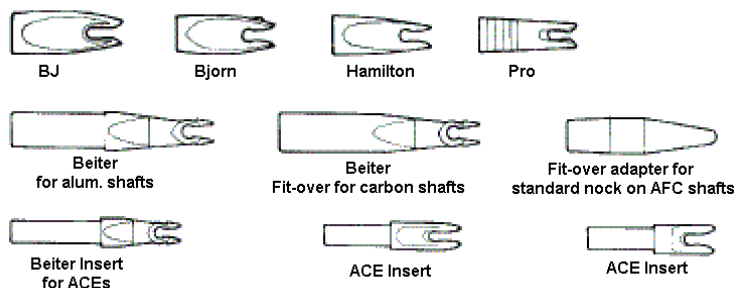

Nocks are made from rigid plastic and are glued to the rear of the aluminium arrow. For carbon arrows, the nock is typically a push fit. The top row shown in the picture are used for aluminium arrows. Nocks come in 6 different sizes to suit the range of diameters of arrows. The nocks are shaped so that they will

clip onto the bowstring and hold the arrow in place. The other nocks shown are specifically for 'Beman' carbon arrows and 'Easton A/C/E' carbon/aluminium arrows.

In the case of carbon arrows, if the nock appears too loose – adding one or two turns of thin tape (PTFE is ideal), or a dab of paint, is often enough to tighten the fit.

If using the PTFE tape method, wrap the tape so that approximately 60% of the tape is on the nock shaft, and the other 40% below. Two or three wraps should be sufficient. Once done, take the 40% below and twist it. This will assist in holding the tape in place as the nock is inserted into the shaft. Push the nock into the shaft, twisting as you do so, but before fully inserting it, remove any PTFE tape remaining visible above the end of the shaft.

New nocks have recently been brought onto the market specifically for ACEs and X-10s called "pin-nocks" which consist of a metal pin which fits into the back of the arrow, and a plastic nock which locates on the pin – these nocks are intended to protect the arrow in the event of rear-impact.

To attach nocks to aluminium arrows, apply a small amount of 'Fletch-Tite' to the rear of the shaft, place the nock onto the shaft and then twist to evenly spread the glue. Take care to align the nock with the cock fletch, then wipe off any excess glue. Allow the glue to set.

To remove a nock, immersion in hot water is usually enough to melt the glue and allow the nock to be twisted off.

If a nock has been widened by rear-impact and is otherwise OK, heating in hot water for 10 seconds is usually enough to soften the nock so that it can be pinched back into shape.

**NEVER** try to shoot an arrow with a damaged nock... the nock might not be the only thing which ends up damaged!

## 2.2.8 Maintenance

Always check shafts and fletchings for damage. The arrow can be checked for straightness by holding the shaft vertically, the point in the palm of the hand and spinning the shaft with the thumb and second finger. This takes a bit of practice, but is an excellent guide to straightness. Carbon shafts should be checked to ensure that there are no splits or cracks in the carbon fibre. These can be difficult to see but become more obvious when the shaft is flexed.

Fletchings should be undamaged and should have no folds or creases.

## 2.2.9 Jargon

“Archer’s paradox”

During release, the string must move “around” the fingers. This causes the string to impart a sideways force to the arrow and the arrow bends towards the bow. The arrow then returns to straight and begins to bend away from the bow – this continues all the way to the target. This is called the archer’s paradox.

“Node points”

During flight the arrow exhibits a bending movement and the node points are the two points on the arrow, one close to the front and one close to the rear which do not move relative to the axis of travel. If the node points are aligned behind one another, then the arrow flight will be more accurate – this is achieved through tuning. (See Node Points section for more detail)

## 2.3 Sights

A sight is a sight right? No. There are many sights on the market which will suit the recurve archer, costs vary from £5 to over £200. So what makes one sight better than another?

### 2.3.1 Construction/materials

First of all, a sight is your only point of reference, so it **MUST** be solid in construction and must be able to withstand the vibration in the bow without shaking loose. Most sights have a variable length sightbar which allows the sight ring to be placed as far forward as possible – this means there’s extra weight out in front of the bow, so many sights carry the vertical scale back at the bow riser rather than the more traditional “out-front” design. Similarly, most of the sights available are made from aluminium or carbon, or a mixture of both to maximise strength and minimise weight. The mass of the sight in comparison to all of the other “gadgets”, such as a long-rod and v-bars, is minimal, so go for what you can afford, but make sure you try the sight first to ensure it has the adjustments you require and that it can be locked down.

### 2.3.2 Cost

Will an expensive sight improve your scores? Very unlikely. The main thing to look out for is a sight which locks down nicely and will not shake loose, but even the reasonably priced Arten Summit sight at just above £50 will do the job nicely. If you’re paranoid about the forward weight, then the Arten Olympic sight at just below £90 will suffice. When you’re good enough to be sponsored by one or more manufacturers, then demand only the most expensive!! When you have reached a good level of proficiency, then it is a good idea to have a sight which will allow small repeatable adjustments in elevation (vertical adjustment) and windage (horizontal adjustment), so look for a sight which has some sort of fine and coarse scales on it (often the fine scale can be found on the adjustment screws themselves).

### 2.3.3 Sight pin/crosshair/sight ring?

Many experienced archers shoot with only an open sight ring. For some reason this scares novices witless. BUT having a sight pin or crosshair can encourage over-aiming and the last thing an archer must do is consciously aim too hard (see technique section). The human brain is EXTREMELY good at centering concentric circles (try putting a coin in the middle of a plate... you'll be amazed at how accurately you can position the coin), so since the target pattern is round, and the sight ring is round, why not let the brain do its work – it's one less thing to worry about,

Again, it's a personal thing and everyone is different, but try it – you may find you like it.

### 2.3.4 Sightmarks

Make sure, before going to competition that you get the opportunity to shoot the distances you will be shooting at the competition. **MAKE A NOTE** of the sight settings (the horizontal as well as the vertical position), and the weather conditions at the time (wind strength/direction, wet/dry, etc) In general a head wind will depress an arrows flight and therefore cause it to impact lower than normal. Similarly, rain will cause the arrow to drop slightly shorter. If possible. Don't just take one set of sight marks, take a range in varying conditions. Those first few arrows at each distance can cost dearly if the competition is close.

## 2.4 Arrow rests

There are three main types of rest for the finger-shooting recurve archer:

- The basic rest. Formed from moulded plastic. An arm, usually with a slight “hook” at the end, bends out of the way when it comes into contact with the fletchings. No variability. Cheap and cheerful. Will do the job admirably. £1-£2
- The flip rest. Formed from metal with a thin metal arm which is spring-loaded. For those with a sensitive setup – perhaps the arrow is catching on the rest arm, causing deflection of the arrow flight. This rest provides smoother, faster reaction than the plastic variety. £4- £10
- The magnetic rest. Similar to the flip rest, but with the movement of the arm controlled by magnets. These often provide additional adjustments of the arm up/down to allow centering of the arrow on the pressure button. £15+ but should last forever. These rests also provide even smoother reaction than the flip rest, but to be honest, if your arrow flight is THAT sensitive, then you may have other clearance problems.

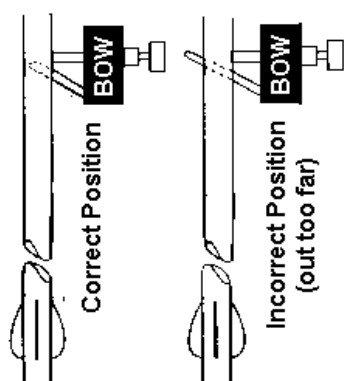

When setting up an adjustable rest, it is best to ensure that the tip of the rest does not extend beyond the outside of the arrow as shown in the diagram.

## 2.5 Pressure Buttons

The pressure button is used when tuning to:

- Set the “centre-shot” i.e. to align the arrow so that it is pointing slightly away from the bow (see tuning section)
- Set the pressure of the reaction which acts against the arrow forces pushing towards the bow.

A ‘Pressure Button’ can be used when the bow riser has a threaded sleeve fitted.

The arrow rest must be adjusted so that the centre of the arrow and the centreline of the pressure button align.

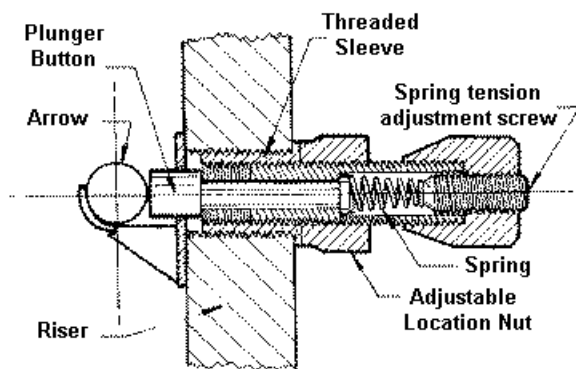

The button consists of a spring-loaded plunger mounted inside a threaded metal housing. On the housing are two locking collars, the collar closest to the plunger (location nut) is used to set the position of the tip of the button relative to the side of the riser. The rear collar is used to hold the spring tension adjustment screw. Turning the spring tension adjustment screw compresses or expands the spring, causing the button to become stiffer or weaker respectively.

There are many pressure buttons on the market from the excellent Shibuya DX (£20) to the horrendously expensive Beiter super button (£60). Any of these buttons will suit the novice to intermediate archer. Some buttons provide a tip which can be unscrewed – this may sound like a good idea, but if your arrow is slightly low or high of the centre of the button, then you can rest assured that the thing WILL unscrew when you least expect it... my personal preference is to choose a button with a solid tip which cannot unscrew by itself.

### 2.5.1 Setting up a second button.

Got a second button? Want to set it the same as your current button? Easy! Turn the buttons so that they are pointing in opposite directions (plungers towards one another). Position each plunger against the location nut of the other button and use this to set the position of the front collar on the new button.

To set the pressure, simply put both plungers together and push gently. One will move before the other. Simply adjust the pressure in the new button until both buttons move at the same time and by the same amount. And that's all there is to it.

### 2.5.2 Maintenance

It is a good idea to regularly check and clean the button. To do this without affecting the button setting, simply unscrew the grub screw holding the rear collar and unscrew the collar – this should provide access to the spring and plunger. Make sure these are clean and undamaged. DO NOT add oil or any other lubricant.

## 2.6 Stabilisers

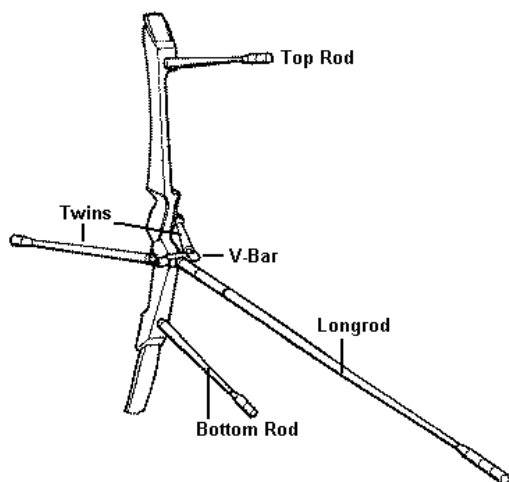

The first anti-torque bow was introduced in 1961 by Earl Hoyt. (Yes, they've been around that long!) The same man later introduced TFCs (Torque Flight Compensators) to top and bottom rods to improve the after-shot feel.

By the end of the 60s other 'active' systems had appeared on the market including rods with barrels filled with mercury, water, oil and other liquid-like materials to absorb energy.

Later came the advent of foam and sand to replace the liquids in an attempt to provide that all-important absorption.

Many modern-day archers use lightweight, stiff, aluminium or carbon rods with Doinkers(tm). These are rubber mountings which are fitted

between the rod and the end-weights in order to dampen vibration.

Alternatively the newest “kid on the block” is the multi-rod stabiliser comprising several thin rods with a moveable weight which allows the archer to “tune” the stabiliser.

Stabilisers are used for three purposes:

1. To provide a nicely balanced, smooth feeling bow which is easy to get onto the target.
2. To increase the moment of inertia to reduce the possibility of torque affecting the arrow flight.
3. To cut down vibration during and after the shot

A long rod will probably make most difference initially. Don't start by putting loads of stabilisers on the bow, start with just a long rod, and if you want, add other stabilisers to change the feel and balance of the bow. Even try multi-rods if you really need more gadgets!

Do not put too many stabilisers on for you to comfortably control; you shouldn't have your bow hand drop uncontrollably when you make a shot. In the long run, stabilisers will improve your accuracy, but don't use them as a substitute for a good technique. Just because you can hold the bow steadier for longer with stabilisers doesn't mean that you should!

## 2.7 Other accessories

### 2.7.1 Bracer (arm guard)

Arm Guards are reinforced leather or plastic protective guards that are worn on the inside of the bow arm.

They are worn to protect the arm from the bowstring as it moves forward after the release. The ideal condition is that the string never hits the bracer, as this will affect arrow flight – but it's better to be safe than sore!



### 2.7.2 Tab



**Tab with  
finger separator**

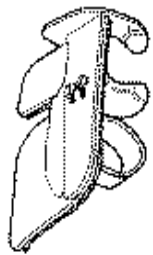

**Tab with shelf**



**Tab in use**

Finger Tabs are used to protect the fingers as they release the bowstring and also provide a smooth surface for the bowstring to slide on. Most finger tabs are made from leather or synthetic materials with some having multiple layers of material for extra protection. Other types of finger tabs can have attachments as shown in the picture, to help keep the fingers apart and anchor under the jaw.

The size of finger tab should not be any longer than the finger tips.

### 2.7.3 Quiver

A ‘Ground Quiver’ made from steel rod is spiked into the ground to hold the bow and arrows.

A ‘Belt Quiver’ and ‘Holster Belt Quiver’ hold the arrows and, if fitted with a pocket, can hold spare nocks, fletches, arrow puller, tube of glue, rabbit's foot, cuddly toy, etc.

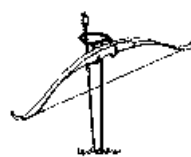

**Ground  
Quiver**

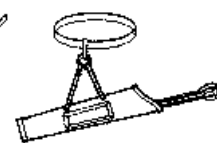

**Belt  
Quiver**

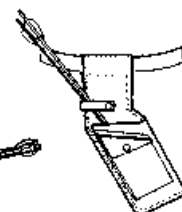

**Holster Belt  
Quiver**

## 2.7.4 Chest Guard

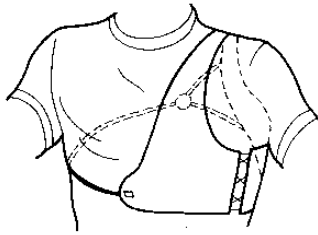

A Chest Guard is used to prevent injury to the breast. The prolonged repetition of pressure from the bowstring can lead to the formation of a lump within the fatty tissue, which is clinically difficult to tell apart from cancer tissue without a biopsy.

They are also used for the purpose of keeping loose clothing from interfering with the bowstring, especially if wearing clothing for colder or wet weather. The chest guard is made from a nylon, soft leather or plastic open mesh material held around the chest with an elasticated strap.

## 2.7.5 Slings

A sling is an adjustable strap used to prevent the bow falling to the ground. This allows the archer to shoot with a relaxed bow hand and thereby allows the shot to be executed with minimal torque to the riser from the hand grip, and also minimises the shot-to-shot variation experienced when the riser is gripped. All types of sling work well and it is very much a personal preference which one to use.

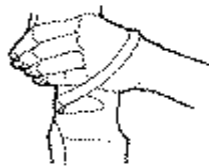

**Bow Sling**

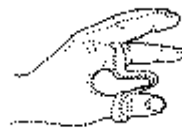

**Finger Sling**

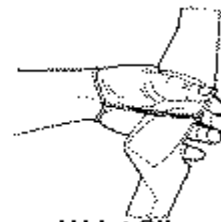

**Wrist Sling**

The 'Bow Sling' is attached to the bow, usually just below the grip. The sling should fit loosely over the hand. After release the strap will press on the top of the hand and the bow will be supported by the strap only. Advantage(s): Easy to adjust. Disadvantage(s): This type of sling tends to allow the bow to swing if the bow leaves the hand completely, which can be off-putting, especially if the limbs swing up near the archer's face!

The strap should not press down on the hand or wrist during the shot.

The 'Wrist Sling' does the same job, but is attached to the wrist and a loop is placed around the bow and clipped to the loop around the wrist. Advantage(s): Easy to adjust. Feels secure. Disadvantage(s): Initially can feel a little flimsy and awkward.

The 'Finger Sling' can be a strap of leather or a length of string with a loop at each end. It is attached between the index or middle finger and thumb with the bow loosely held in the hand. This is the favoured sling of many top archers. Advantage(s): Free movement in the hand. Small and light. Disadvantage(s): Not easy to adjust. Get one which fits you and your bow! Most finger slings will fit the average archer/bow though. May feel awkward if the loops are not tight enough.

With any bow sling, it takes time to learn to trust it. When shooting, make sure the bow slides forward in your hand after release – this is the best indication that your bow-hand is relaxed.

## 2.7.6 Clicker

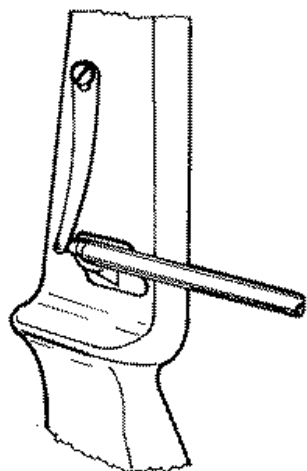

The 'Clicker' is usually a strip of spring steel attached to the riser. The arrow is placed under the clicker so that at full draw, the arrow point will be pulled from under the clicker. It will then snap back against the bow making an audible 'click' noise. At this sound the archer will release the arrow.

The purpose of the clicker is to aid consistency as even half an inch difference in draw length can make a significant difference to the power in the shot and therefore the vertical distribution of the arrows.

Before an archer can use a clicker, their draw length must be consistent, otherwise it will be more of a hindrance than a help.

To set the clicker in the correct position, no more than half the length of the arrow point must be left under the clicker at full draw. If too much length is left under the clicker, it will take too much effort to pull that extra amount while keeping the sight steady.

Never has a single device crippled so many archers! The clicker is the source of many psychological problems to so many archers who develop a tendency to react to the clicker. It soon becomes the norm to release the arrow at the slightest click – even the clicker of the archer standing next to them! This is due to an unhealthy dependence on the clicker. It is important to teach the subconscious that the clicker is not the end of the shot – it is, in fact the middle. The clicker is an indication that we have reached a point at which we could release “IF WE WANTED TO”.

It takes a significant amount of time to learn to use a clicker properly. Korean archers begin with a clicker on day one, which means they never learn to stop/aim/release, and if there's any secret of success to archery it is this: “Continuous motion” (see technique section). It is very difficult, when stopped, to start again, so we get into the power struggle – us vs. the clicker... and the clicker ALWAYS wins.

Having said all that, a clicker is essential for most competitive archers and learning clicker control is crucial to good performance.

It is important to ensure that the clicker does not depress the pressure button, i.e. that the tension on the clicker is not greater than that of the pressure button plunger. If this is the case, then the arrow will spring away from the bow after the clicker drops. To check this, pull the arrow through the clicker four or five times and watch the point carefully. The point should not move when the clicker drops.

If the arrow is too long to use a standard clicker, clicker extenders are available which mount on the front or side of the bow and give the clicker a platform on which to click. Alternatively, magnetic clickers are available (Cavalier and Golden Key are two manufacturers of such devices) which mount under the sight mount, or on the sight extension bar and have a long stainless-steel rod which rests on the arrow. NOTE These clickers are very light and can cause problems if shooting in windy conditions with the arrow being blown off the rest! However, the upside is that shooting THROUGH these rests (i.e. losing an arrow before the clicker drops) has much less damaging consequences on your fletchings OR on your score!

## 3 Tuning

Note: These instructions are for finger-release recurve shooters only.

### 3.1 What?

Tuning is the process of matching the archer, the arrow, the bow and the rest of the equipment (including the string, pressure button, etc.). It sounds like a complicated process, but in fact in its simplest form can simply be a case of shooting a couple of extra arrows each end and following the simple instructions below.

### 3.2 Why?

Tuning enhances accuracy in two ways:

1. It helps to ensure that the arrow leaves the bow in the same way every time.
2. It helps the archer by making the bow system more forgiving of poor technique and minor mistakes.

### 3.3 How?

The bow should be tuned in five steps, and in this order... otherwise you'll be tuning for ever more. **Be aware**, however, that you'll only ever be able to tune your bow as well as you can shoot it!

#### 3.3.1 Step 1 – Preliminary Setup

First of all, the arrow must be close to the correct spine for the draw weight and style. An incorrectly spined arrow will be difficult, if not impossible, to tune (although a slightly stiff spine is easier to tune than one which is too weak). Refer to the spine chart for the supplier of the arrows. This is assuming, of course, that you know the draw weight of your bow. If not, ask someone to weigh it for you using a bowscale.

(NOTE: Most bowscales are very inaccurate below 40lbs, so use one which has been calibrated with static weights if possible)

If the arrow is incorrectly spined, then things can be done to change that situation, but these will be dealt with later.

Prior to tuning, carry out the following checks:

Ensure that the arrows are straight, properly fletched and have perfectly straight nocks.

Ensure that the bow is set up as it would be for normal shooting, i.e. the correct bowstring, sight, stabilisers, rest, pressure button, etc.

Ensure that the pressure button will not interfere with the fletchings (if so, rotate the nocks to ensure clearance).

Set the centre of the sight over the centre of the shaft.

Set the pressure button tension to a medium setting

#### 3.3.2 Step 2 – Bracing Height

Get the bracing height right. Listen to the shot – does it sound good? Does it sound harsh? Set your bow at minimum bracing height and increase it steadily to maximum and listen to the bow (or better still, have someone else listen) as it is shot.

An archer by the name of Marcel van Apeldoorn suggested the following method:

Go to a long distance where your groups are still nice and tight (e.g. 50m perhaps 70m) and start at the lower end of the manufacturers recommendation. Shoot some arrows (e.g. 18) and chart the vertical position of each arrow. Raise your brace-height slightly (e.g. 1/16 or 1/8 inch at a time) and again shoot some arrows. Also make a mental note of the noise the bow makes, or ask someone else, because you're too busy shooting and you shouldn't be paying attention to anything else but making one good shot (each time). Keep raising your brace-height until you are at the max. recommended brace-height. **KEEP YOUR SIGHT ALWAYS THE SAME.**



When you start at the lower end, the arrows hit somewhere on the target, raising the brace-height will probably make the arrows hit a bit higher than before, raising the brace-height a bit more will reduce the effectiveness of the bow, and the arrows will start to hit lower on the target.

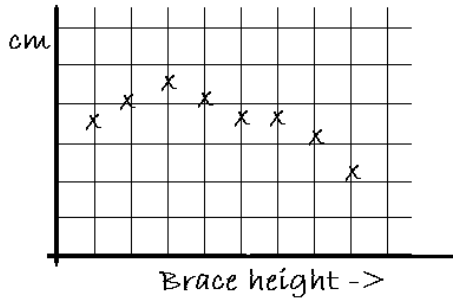

**NOTE:** It is VERY important that you check your nocking point each time, and make sure that it is the same, because raising and lowering your brace-height could have an effect on your nocking point (the effect increases when your tiller difference increases). Choose the brace-height that gives the highest groups on the target, because it means that the energy-transfer from bow to arrow is at its maximum. The energy that is left behind in the bow, and produces the sound AND vibrations at this point is at a minimum.

### 3.3.3 Step 3 – Nocking Point

Set the correct nocking point height. If the nocking point is incorrect then the arrow will “porpoise”, i.e. the point and tail of the arrow will oscillate in a vertical plane.

The nocking point can be checked in several ways:

1. Paper tune. A frame is placed about 2 metres (6 feet) in front of the target. A sheet of paper is placed taut over the frame. The archer then stands about 1 metre (3 feet) in front of the frame and shoots the arrows through the paper. From the direction of the tear in the paper, the nocking point can be adjusted.

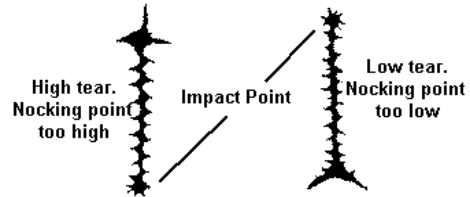
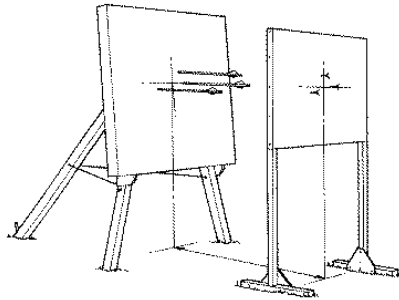

2. Bare-shaft test. The theory behind bare-shaft tuning is that a bare shaft will continue on in the direction it was shot since there are no fletchings to stabilise it, and will therefore give a true representation of any deviation from true.

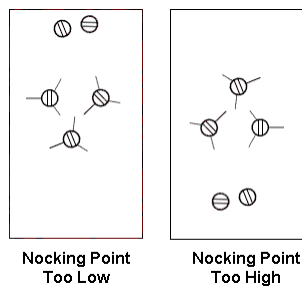

Shoot at least three fletched shafts and two identically aimed unfletched shafts at a target at a distance of 15 to 20 yards.

If the unfletched shafts impact above the fletched shafts, the nocking point is too low., if the unfletched shafts impact below the fletched shafts, the nocking point is too high (it is sometimes desirable to have the bare shaft impact just slightly below the fletched shafts to ensure that the nocking point is not too low as this could cause clearance problems.

### 3.3.4 Step 4 – Centre Shot

Centering the arrow is used to ensure that the “nodes” of the arrow leave the bow in direct alignment to the target. (See Node Points section)

First of all find the centre of the bow limbs. To do this, place a piece of masking tape across the inside of each limb a few inches from the riser. Mark the centre of each limb on the tape.

Rest the bow by hanging it over the back of a chair, using the stabiliser/riser as a hook.

NOTE: it is important NOT to put any pressure on the limbs.

Nock an arrow and stand behind the bow, looking at the back of the riser. Looking through one eye and aligning the string with the marks on the masking tape, check the position of the arrow in relation to the string.

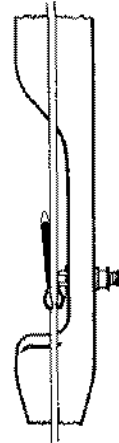

If the arrow were absolutely central, then the arrow would align with the string, however, due to the bending motion imparted by a finger release, this is not desirable in such a setup.

Adjust the pressure button position until only the diameter of the arrow at the point is to the left of the bowstring (for right-handed shooters).

Once this has been done, lock off the adjustment collar of the pressure button and leave it alone!

### 3.3.5 Step 5 – Arrow spine

If the arrow spine is incorrect, then “fishtailing” will occur. I.e. the point and tail of the arrow will oscillate in a horizontal plane.

First of all, set the pressure button spring tension to a medium setting.

There are several ways to check for fishtailing, but by far the most reliable method is the bare-shaft test. Some archers use paper tuning but this method is more appropriate for compound archers and is highly unreliable for finger shooters as the arrow WILL leave with some side-side motion, and the paper tear will vary, depending on how far the archer is from the paper.

**The instructions below are for a right-handed archer and should be reversed for a left-handed archer.**

Shoot at least three fletched shafts and two identically aimed unfletched shafts at a target at a distance of 15 to 20 yards.

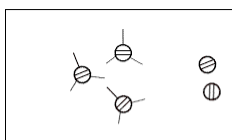

Shaft Too Weak

If the unfletched shafts impact right (weak) of the fletched shafts, increase spring tension, decrease bow weight or decrease arrow point weight.

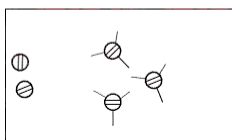

Shaft Too Stiff

If the unfletched shafts impacts left (stiff) of the fletched shafts, either decrease the pressure button spring tension, increase the bow weight or increase the arrow point weight.

If you cannot get your bareshaft into the group then check for clearance (see below)... if the shaft is bouncing off the riser or something else, then it's never going to tune. Remember also to check your limb alignment (see section 2.1.4.2). Remember too, that a button which is TOO soft may bottom-out (i.e. reach the limit of its travel), causing undesirable effects.

### 3.3.6 Step 6 – Clearance

Once the shaft is basically tuned, spray dry powder foot spray, dry deodorant or similar product onto the last quarter of the arrow shaft, fletching, arrow rest assembly and sight window near the arrow rest, then shoot the arrow (being careful not to disturb the powder). Check the powder for lines.

If there are clearance problems:

- If the arrow fletching is hitting the arrow rest, try rotating the arrow nock 1/32 of a turn. Continue rotating the nock until clearance is achieved.
- Check that the arrow rest support arm does not protrude past the outside of the arrow shaft when the arrow is resting on the arm and is lying against the pressure button.
- Try lower profile fletchings
- Try modifying your setup (stiffer/weaker arrows), different rest, etc.
- Move the pressure button slightly out from the bow, if all else fails.

### 3.3.7 Step 7 – Compensating for incorrect spine

If you are shooting too weak a shaft, decrease draw weight, decrease the point weight, increase number of strands in the bowstring, decrease brace height. You might also try adding metal nocking points instead of dental floss.

If the shaft is too stiff, increase draw weight, increase the point weight, decrease number of strands in the bowstring, increase brace height.

Do not modify the point weight outwith the acceptable balance point range (FOC or Front Of Centre). Easton recommends the following ranges for target arrows:

Aluminium arrows:	7-9%
ACCs	9-11%
ACEs	11-16%

To calculate the FOC as a percentage, use the following calculation:  $\frac{100 \times (A-L/2)}{L}$ , where A is distance from nock groove to balance point of finished arrow (including point, fletchings, etc). and L is the shaft length (distance from nock groove to end of shaft).

## 3.4 Adjusting the tiller

The tiller is the name given to the balance of the limbs. Say, for example, you had a 38lb top limb and a 36lb bottom limb (yes, unlikely – but bear with me)... then the bow would tend to tilt upward due to the excess load developed by the top limb, causing difficulty aiming! This is an extreme example, but is to illustrate the point only. While the other tuning points mentioned above are focused on tuning the arrow to the archer, adjusting the tiller is more concerned with adjustment of the bow to the archer.

Modern bow limbs are usually manufactured as a matched pair, so why adjust the tiller? Simply because the riser and grip is not symmetrical. There are two adjustments which can be made to account for this:

#### Dynamic tiller

This is the force applied to the string by both limbs after release. Adjusted by tuning the nocking point (see previous section)

#### Static tiller

This is the force applied to the string by both limbs during the draw. Adjusted by changing the limb angle (by fitting shims or some other method). The recommended static tiller is usually somewhere between 1/8" and 1/4". This is measured by taking the distance from the limb (where the riser and limb meet) to the string (at right angles to the string). Typically the bottom limb is 1/8" closer to the string than the top limb. HOWEVER. The way the archer holds the string and the bow will determine the actual position required for that archer.

To test static tiller, stand at 18m/20yds from the target (40/60cm), and put the sight on the target. Draw the bow VERY SLOWLY back to the anchor point. It is important that the hand moves directly to the anchor point, and that this is done slowly.

If the pin moves up, increase the tiller (increase lower limb poundage or decrease upper limb poundage). Similarly, if the pin moves down, decrease the tiller (decrease lower limb poundage or increase upper limb poundage).

### 3.5 Other Tuning Methods

Both of these methods require significant time and skill to carry out properly and are sometimes regarded to be more trouble than they're worth for the average archer.

#### 3.5.1 Cushion plunger tuning (Vic Berger method)

This is often used as a final check after bare-shaft tuning. (these notes are again for a right-handed archer).

- Shoot from 15 meters or yards, using fletched arrows to establish a group.
- Make an aiming point 4 to 6 inches below the top of the target.
- Leave sight as set, using new aiming spot, shoot 1 arrow at each of the following distances – 5, 10, 15, 20, 25, 30, 35 metres, etc., until the arrows come near the bottom of the boss. Refer to the following diagrams, and adjust pressure button accordingly, until ideal set up is achieved.

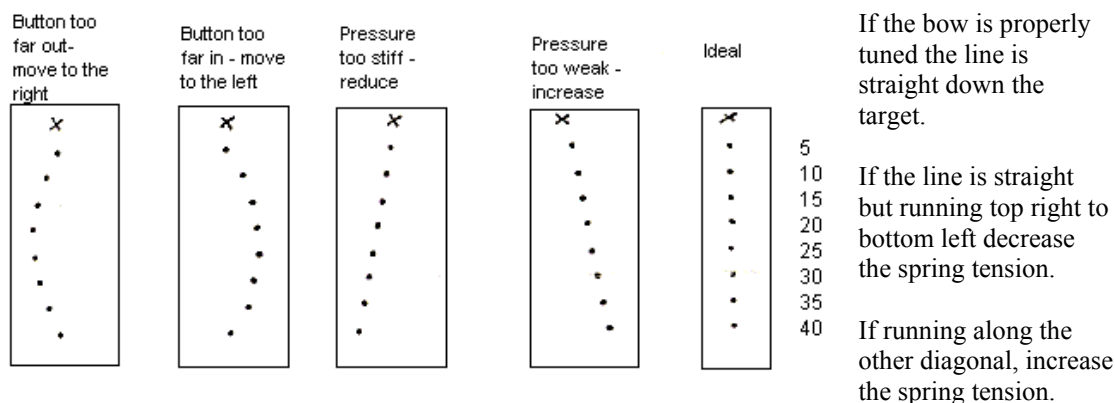

If the line curves to the left then back to the centre then the button is too far out, if to the right it is to far in.

Adjust the settings until there is a straight, vertical line. If you've had to make any of these adjustments then go back to bare shaft until the methods agree!

#### 3.5.2 Short Distance Tuning, Fine Tuning and Micro tuning

These are all subjects for a later time!

#### 3.5.3 Tune for tens (a complete tuning guide from Rick Stonebraker)

This section is a complete tuning guide written by Rick Stonebraker. This guide first came to my attention when someone mentioned the "solid button or matchstick" tuning method. Intrigued, I asked for a copy of this guide.

Rick's achievements in the archery world speak for themselves. Rick holds several Texas state records and 15 or so state field, target and indoor titles. He is on the national archery association board of governors, is an NAA level 4 national instructor, national judge, and Olympic judge. This list is not exhaustive!

I have included his guide here in its entirety, and with his original wording. Some of the advice included here mirrors that of previous sections, but this system is devised as a start-to-finish process and therefore to break it up would detract from the system.

## Tuning

An important part of archery is the equipment. The skill of the archer is also important but if the bow is not properly tuned, the archer's skill is reduced. Tuning can be achieved in a short period of time. The archer that puts the most time and effort into equipment, will have the most success.

## Plunger



The PLUNGER has a SPRING to allow horizontal movement of the arrow. When tuned properly, the PLUNGER will prevent the arrow from moving in past centre in case of a bad shot.

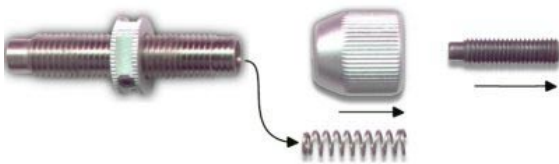

Remove the SPRING from the PLUNGER.

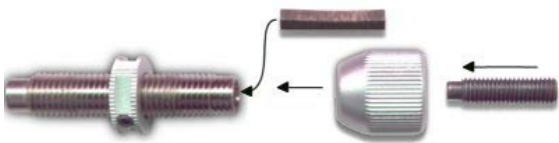

Cut a wooden MATCH or a piece of WIRE about  $\frac{3}{4}$ " long. This will make the PLUNGER stiff. The STIFF PLUNGER will help tune the arrow shaft.

## Install/Adjust Plunger

*NOTE: This method is the same for left-handed archers*

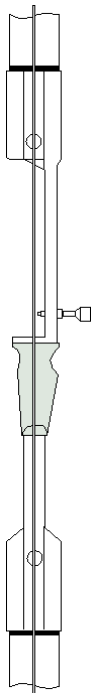

### Install Stiff Plunger

- Remove the centre stabiliser.
- Remove the sight if necessary.
- Lean the top of the bow against a wall to allow a clear view of the alignment.
- The string should be in the centre of the limbs.

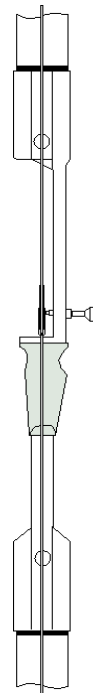

### Adjust Stiff Plunger

- Move the stiff plunger in/out so that the bare shaft is directly in the centre of the bow.
- The string should be in the centre of the arrow.
- Install the stabiliser and sight.
- The bow is ready to shoot.

## Paper Tune Setup

This method will:

- (1) Determine if the nock point is correct. This can be corrected.
- (2) Determine if the arrows are stiff or weak. This may or may not be corrected.

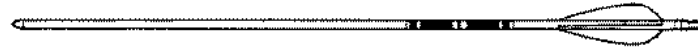
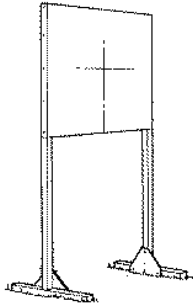

**ARROW**



**BARE SHAFT**

### TUNING FRAME

The TUNING FRAME consists of a frame to hold a sheet/piece of paper.

Stand 5-6 meters from the tuning frame. The target matt should be at least 1 meter behind the frame. This will allow the bare shaft to pass completely through the paper.

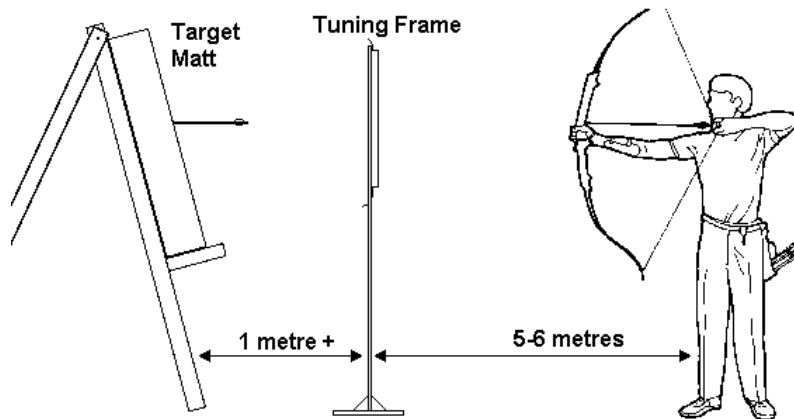

Shoot a bare shaft about shoulder high to allow for a parallel flight. The tear of the paper will determine the current tune. We will adjust the vertical tear first.

## Nock Point

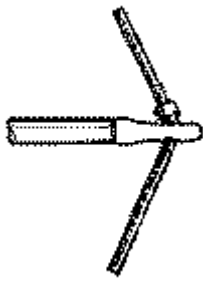

**Nock Point**

Figure 1. TEAR UP. The point of the bare shaft went in low and the nock went in high. The NOCK POINT is too high. Move the NOCK POINT down.

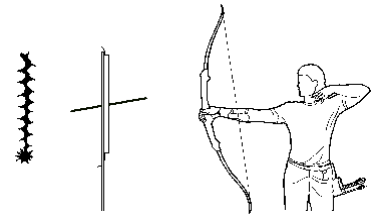

**Fig.1**

Figure 2. TEAR DOWN. The point of the bare shaft went in high and the nock went in low. The NOCK POINT is too low. Move the NOCK POINT up.

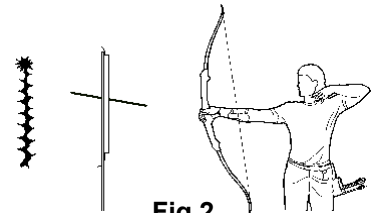

**Fig.2**

Adjust the NOCK POINT until the tear is neither up, nor down.

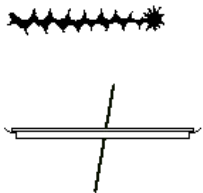

**Fig.3**

Figure 3. LEFT TEAR. The point of the bare shaft went in to the right. The nock tears the paper to the left.

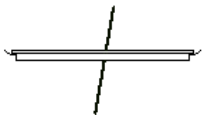
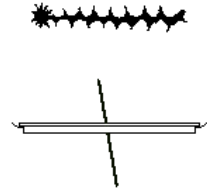

Figure 4. RIGHT TEAR. The point of the bare shaft went in to the left. The nock tears the paper to the right.

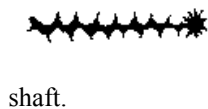

**Fig.4**

The next section will adjust the horizontal tear.

## Horizontal Tear

### RIGHT HANDED ARCHERS



The figure shows a LEFT TEAR. The shaft is too weak. If the tear is 1-3 inches, the shaft can be stiffened by decreasing the weight in the point or decreasing bow weight. If the tear is greater than 3 inches, the shaft is too weak. Select a stiffer

shaft.

The figure shows a RIGHT TEAR. The shaft is too stiff. If the tear is 1-3 inches, the shaft can be weakened by increasing the weight in the point or by increasing bow weight. If the tear is greater than 3 inches, the shaft is too stiff. Select a weaker shaft.



- ✱ A tear less than 1 inch, right or left is okay. A single hole is ideal.

### LEFT HANDED ARCHERS

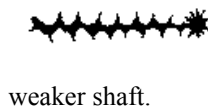

The figure shows a LEFT TEAR. The shaft is too stiff. If the tear is 1-3 inches, the shaft can be weakened by increasing the weight in the point or by increasing bow weight. If the tear is greater than 3 inches, the shaft is too stiff. Select a weaker shaft.

The figure shows a RIGHT TEAR. The shaft is too weak. If the tear is 1-3 inches, the shaft can be stiffened by decreasing the weight in the point or decreasing bow weight. If the tear is greater than 3 inches, the shaft is too weak. Select a stiffer shaft.



✱ A tear less than 1 inch, right or left is okay. A single hole is ideal.

### **Shoot With Stiff Plunger (Right handed archer)**

The STIFF PLUNGER is in the centre of the bow. Shoot fletched arrows from 18 meters. Shoot the best group possible in the centre of the target. Adjust the sight if necessary.

Remove STIFF PLUNGER and install PLUNGER with SPRING.

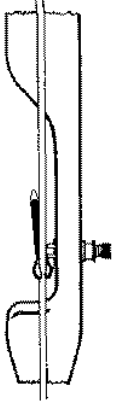

See figure. Adjust the PLUNGER until the right edge of the arrow is in line with the left edge of the string. Do not use the point, use the end of the shaft.

Shoot from 18 meters but DO NOT ADJUST THE SIGHT. Correct the flight of the arrow with the SPRING in the PLUNGER. Shoot the arrows in the same target and shoot the best group possible.

If the arrows are to the left of the centre, weaken the SPRING (Counter Clockwise). If the arrows are to the right of the centre, stiffen the SPRING (Clockwise). Adjust the SPRING until the group is in the centre of the target.

This group should be the same as the group using the STIFF PLUNGER/CENTRE SHOT METHOD. For more fine tuning see “Drop Method” after the next section.

### **Shoot With Stiff Plunger (Left handed archer)**

The STIFF PLUNGER is in the centre of the bow. Shoot fletched arrows from 18 meters. Shoot the best group possible in the centre of the target. Adjust the sight if necessary.

Remove STIFF PLUNGER and install PLUNGER with SPRING.

See figure. Adjust the PLUNGER until the left edge of the arrow is in line with the right edge of the string. Do not use the point but use the end of the shaft.

Shoot from 18 meters but DO NOT ADJUST THE SIGHT. Correct the flight of the arrow with the SPRING in the PLUNGER. Shoot the arrows in the same target and shoot the best group possible.

If the arrows are to the right of the centre, weaken the SPRING (Counter Clockwise). If the arrows are to the left of the centre, stiffen the SPRING (Clockwise). Adjust the SPRING until the group is in the centre of the target.

This group should be the same as the group using the STIFF PLUNGER/CENTRE SHOT METHOD. For more fine tuning see next section.

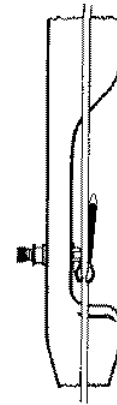



## Drop Method

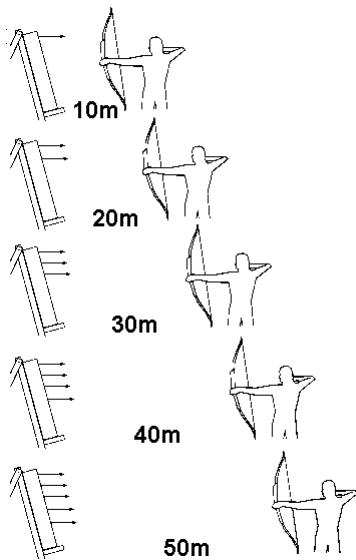

Pick a mark at the top of the target. Shoot from 10 meters and adjust the sight if necessary.

Move back 5 meters at a time and continue to shoot at the top of the target. The arrows will drop down the target.

Move back as far as possible. Approximately 40 to 50 metres for most bows.

If the arrows fall in a straight line, the tune is good, you may skip the “Patterns section”.

If the arrows drift right or left as they fall, more tuning is required, see next section.

## Patterns

### LEFT HANDED ARCHERS

If the arrows fall to the left side of centre, stiffen the SPRING (CW) until the arrows are in the centre line.

If the arrows fall to the right side of centre, weaken the SPRING (CCW) until the arrows are in the centre line.

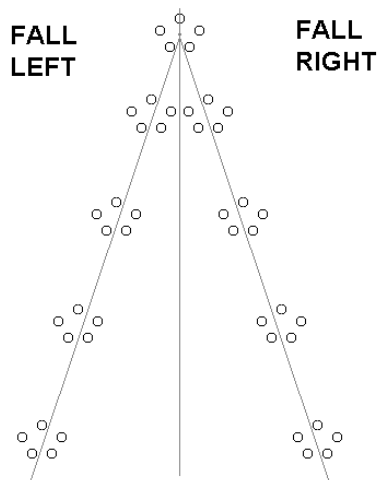

### RIGHT HANDED ARCHERS

If the arrows fall to the left side of centre, weaken the SPRING (CCW) until the arrows are in the centre line.

If the arrows fall to the right side of centre, stiffen the SPRING (CW) until the arrows are in the centre line.

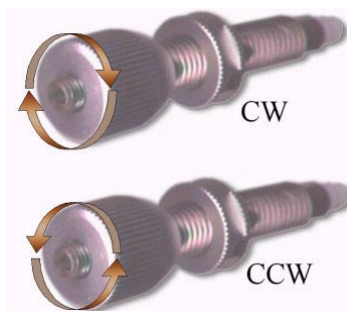

**Note:** Approximately ¼ turn (90°) of the spring will move the arrows 4” at 40 meters.

## Tuning for perfection

This is the beginning of fine tuning. The fine tuning can be done during normal practice. Choose a long distance: 60/70 meters for women, 70/90 meters for men. Shoot 6 ends of 6 arrows. Make a chart of the groups.

Stiffen the PLUNGER (CW) about  $\frac{1}{2}$  turn. Shoot another 6 ends of 6 arrows. Make a new chart for this group. Again, stiffen the PLUNGER another  $\frac{1}{2}$  turn, shoot, and chart.

Continue this procedure until the groups start to open up. Be sure to record the number of turns.

Turn the plunger back to the beginning of this exercise. Weaken the PLUNGER by  $\frac{1}{2}$  turn (CCW) and shoot 6 ends of 6 arrows. Chart the groups. Repeat the exercise as before until the groups begin to open up.

Review all the charts and find the best group. Adjust the PLUNGER to that setting. This should be the best tune.

If there is time (and patience), repeat the above exercise using  $\frac{1}{4}$  and  $\frac{1}{8}$  turns. Excellence takes persistence.

Go to 18 meters and shoot a group in the centre of the target. Now shoot a bare shaft and notice where it lands on the target in relation to the group. For example, see figure 1. The fine tuning has found a better set-up. Do not be concerned if the bare shaft did not group with the fletched arrows.

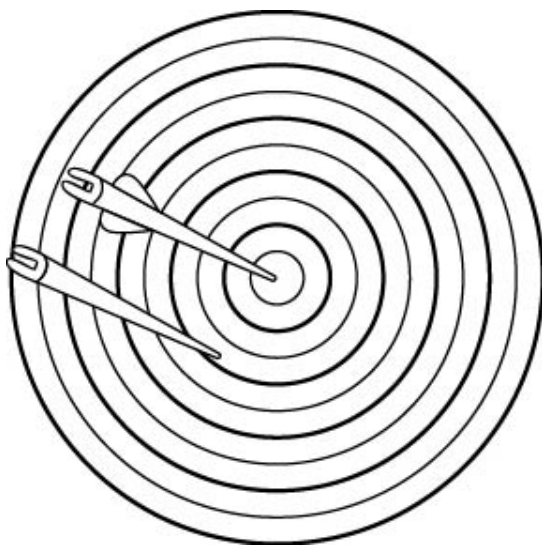

Fig. 1

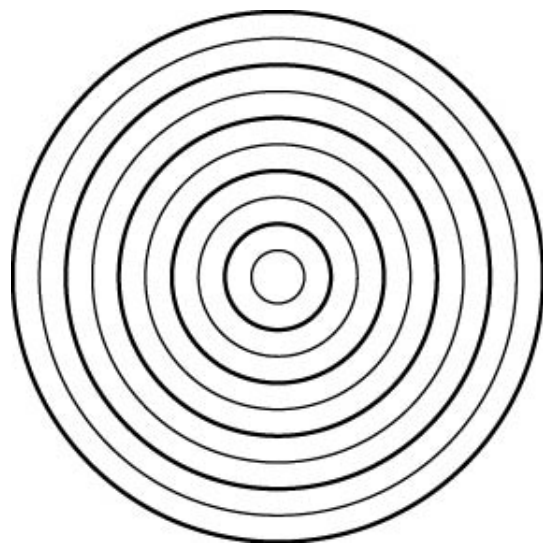

Fig. 2

**Note:** It is important to record where the bare shaft hits in relation to the group. Record this in figure 2 for later use.

If an emergency arises where the bow needs to be re-tuned quickly, set the nock point then adjust the spring tension until the bare shaft hits relative to where the group is, as in figure 2.

## Index Nocks

Are the vanes touching the arrow rest or any part of the shelf when you shoot? Put some red lipstick on the support arm of the arrow rest. See figure 1. Shoot some arrows and see if the vanes are making contact. If there is some lipstick on the vanes, rotate the nock until there isn't any lipstick.

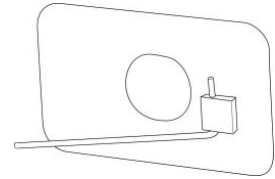

**Fig. 1**

We want to find exactly when the vanes make contact with the rest or shelf. Turn the nock and shoot until the vane begins to rub. Make a mark on the shaft directly opposite the mold mark on the nock. See figure 2. This is where the rub starts for that particular vane.

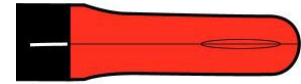

**Fig. 2**

Turn the nock in the opposite direction and repeat the above procedure until the next vane begins to rub. Make another mark opposite the mold mark on the nock. These two marks indicate where the two vanes rub the bow. Turn the nock until the mold mark is directly in between these two marks.

This should be maximum clearance. Mark every arrow the same. See figure 3.

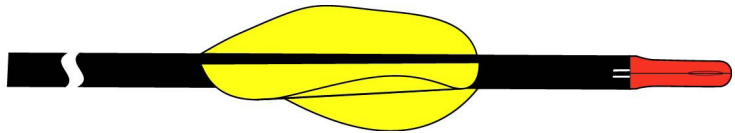

**Fig. 3**

## Record Important Information

	Outdoor	Indoor
Bow weight		
Brace height. #2		
Upper tiller #3		
Lower tiller #4		
Length of string		
Number of strands		
Nock point		
Length of arrows		
Weight of points		
Type of nock		
Type of fletching		
Length of fletching		

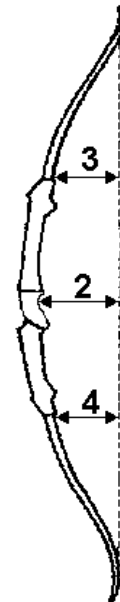

## Note from the author

This method has been used for many years by some of the top archers. There are quicker methods but I believe this is the most complete. This method tunes and gives an idea of how the equipment works.

## 4 Technique

The key to archery is repetition – doing the same thing time, and time again. And the only way to do this is to feel good about your shooting. Be comfortable. Be relaxed. Be confident. And the only way to develop these traits is practice, practice, practice, practice, practice..... shoot as many GOOD arrows as you can. When you can't get a bow and arrows in your hand, shoot in your head. Visualise the shot from inside and out. See the arrows landing squarely in the 10-ring. Like all sports, you will get from archery what you put into it. Above all, remember: if it doesn't feel right, **don't let go!**

### 4.1 The Basics

#### 4.1.1 Warm up!

Often ignored by even the good archers! It is essential to have a good warm-up regime, to help prevent long-term and short-term injury. There are many different styles of warm-up and these are covered in the training section. DO NOT IGNORE the warm-ups... they will help you perform more consistently, and will help you enjoy the sport for many years to come. (See section 6.1.4.1 for warm-up exercises).

#### 4.1.2 Which hand?

There has been much debate on this subject. The majority seem to favour the eye-dominance theory. If you are right eye-dominant, then you should be a right-handed archer. So, how do you tell?

One method is to hold your hands out at arms length and with both eyes open, look through the hole formed by your hands at a distant object. Keeping that object in view, slowly move your hands towards your face until they touch your face. The hole formed by your hands should be over one of your eyes. This eye is your dominant eye and will control your aiming. Another quick way to test your eye dominance is to point your index finger at a distant object with both eyes open, then close one eye and see if your finger appears to move away from what you are pointing at. If your finger does appear to move, then the eye that you closed is your dominant eye. Try again with your other eye and your finger should not appear to move.

Some people simply do not have a dominant eye – both eyes are equally strong. In this case, it is best for a right-handed person to shoot right handed, and vice versa.

#### 4.1.3 Aiming – One eye or both eyes?

This, like so much of the technique section is pure preference. If you don't have a particularly dominant eye, then shooting with both eyes open can cause problems with aiming (two sight rings, one target!), so shoot with your left eye closed (for a right-handed archer), or obscured.

Try both methods and choose what feels best for you.

## 4.2 Stance

The stance is the foundation of the shot – a weak stance will mean a weak shot, and especially poor performance in windy conditions. In the far east, they refer to a strong stance as “standing like a mountain”.

### Stance Checklist

- Stand tall and relaxed (one foot on either side of the shooting line). Don't lock the knees.
- Keep the feet about shoulder-width apart.
- Maintain an even balance on both feet and an even balance between the ball and heel of both feet. The body's centre of gravity must be kept as central and low as possible.
- Keep the same foot position for each shot. This can be done by using marks on the floor (indoors) or foot pegs (outdoors). Foot pegs consist of golf tees or target pins.
- Check that shoulders are square and head is level.

The following diagrams show the usual positions for the feet:

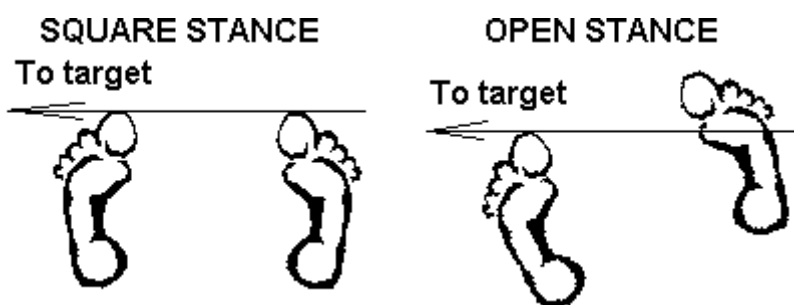

The open stance is ideal for situations where there is a side-wind, where the archer has problems with clearance on bow arm or clothing, or simply where the archer wishes to enhance the “feel” of back tension.

Note that even though the feet are at an angle to the direction of shot, the upper body must be twisted above the waist to maintain the line of the shot. This “line” is important all the way through the shot, so getting it right early on means not having to think about it later in the execution of the shot.

### 4.3 The pre-draw

The pre-draw is the opportunity to get the fundamentals right, establish a good grip on both the bow and the string and relax prior to the shot execution per-se.

#### 4.3.1 Nock the arrow, set the drawing and bow hand

Attach the arrow to the string by pushing the nock firmly onto the finger serving below/between the nocking point(s). It is important to ensure that the arrow is neither too tight nor too loose. To check this, hang the arrow vertically from the string and tap the string. The arrow should drop off the string.

Check that the arrow is resting against the pressure button and is under the clicker (if these devices are fitted and being used).

##### 4.3.1.1 Drawing Hand

Grip the string. For Target Archery the index, second and third fingers are used. The index finger is placed above the arrow nock and the second and third fingers are placed below the arrow nock.

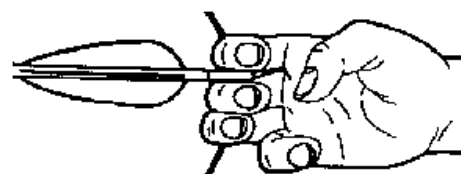

Curl the fingers around the bowstring so that string is resting on or behind the first joint of all three fingers.

Some archers prefer to shoot from in front of the joint (towards the finger tips), thinking that this will provide a cleaner release but in fact this takes well developed hand muscles to do properly and often results in a “plucked” string due to the tension required to hold the string in place (as well as very tired fingers after several arrows)

Modern theory indicates that a deeper hook is more relaxing, and therefore makes for a cleaner release. You may feel that there is an awful lot of finger on the string to be moved out of the way, but the results are exceptionally good. Even with a deep hook, chances are that the string will roll down deep into the first joint during the draw due to the weight of the bow. This has the added advantage for beginners of rotating the string and thereby increasing the sideways pressure on the arrow, helping to keep it on the rest.

Keep a space clear between the index and second fingers and the arrow nock, so the fingers do not touch the nock. (This will prevent ‘pinching’ of the arrow.). A typical symptom of pinching the arrow is that the arrow will be drawn sideways off the rest as the string is drawn back. Some people use a tab with a finger separator for this purpose – others do not. Use what you feel most comfortable with. The designs of different finger separators suit some people and not others. Wrapping a soft tape around the finger separator can often ease discomfort.

Keep the back of the hand as flat as possible. (Relaxed.) The thumb is often tucked into the palm so it can be placed against the neck at full draw. Place a slight pull on the bowstring to set the fingers in position ready for the draw. Beginners should keep an even pressure on all fingers. Experienced archers often vary the pressure with typically about 50% of the weight on the second finger, 35% on the third finger and 15% on the index finger.

#### 4.3.1.2 Bow Hand



Place the bow hand into the grip of the bow with the centreline of the v-shape between thumb and index finger in line with the centre of the bow as shown in the top view.

The base of the thumb muscle should rest on the centreline of the grip. During the draw, the pressure should be taken on the thumb muscle and directly into the wrist. (Low wrist position.)

The thumb and fingers should remain relaxed. If a finger sling or bow sling is not used, then the tips of the fingers are curled around until lightly touching the bow. This will stop the bow falling out of the hand on release.

A consistent hand position on the bow grip is essential to consistent shooting.

Rotate the arm so that when the bow is lifted, the knuckles of the hand are at an angle of approximately 45 degrees. I have found that this is easier to do consistently if the three outer fingers are curled under and tucked in beside the riser.

There are three possible positions for the wrist at this point, all are usually determined by the shape of the grip:

##### High-grip

With a high grip the wrist is raised and in line with the knuckle of the index finger. This gives a good flat line and raises the point of contact to the position between the thumb and forefinger. This grip requires strength to use consistently as the tendency when tired is to drop the wrist.

##### Medium-Grip & Low-Grip

With the medium & low grip, the pressure is lowered to the fleshy part of the thumb. This allows the hand to remain relaxed throughout the shot, reducing the tendency to torque or twist the bow. The medium-to-low grip is the preferred method of most of the top archers.

##### Pre-draw Checklist 1

- Check arrow is nocked securely. Check that shaft is not sitting on top of the pressure button. (a common mistake!)
- Establish comfortable medium to deep grip on the string.
- Set the knuckles of the bow hand to 45 degrees and check that the grip is comfortable and in the right place.
- Check that the hands are relaxed.

#### 4.3.2 Bow arm & drawing arm

The bow arm is one of the most critical parts of the shot (the other being the release and follow through) it must be stable and strong throughout the shot, and of consistent length from shot to shot (this may sound comical but read on...). In order to achieve strength, the archer should aim to keep the shoulder aligned with the socket as much as possible, and this can be done by maintaining a slightly low shoulder (not TOO low – this has to be a natural position, not forced). Check this in a mirror. Raise the bow arm by rotating at the shoulder and check to see that the shoulder stays low.

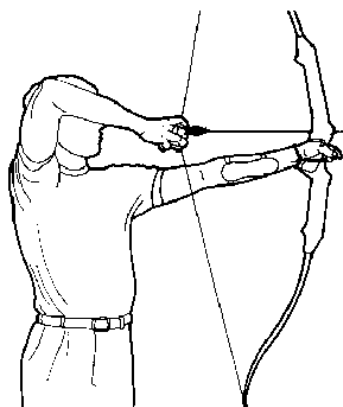

Keeping the shoulder down will also stop it rising up during the draw, and thereby shortening the draw and as a result moving the clicker out of reach.

Keep the elbow of the drawing arm high – this will make it easier to correctly use the large back muscles, and therefore allow the drawing arm and hand to remain relaxed.

#### Pre-draw Checklist 2

- Settle the hand position into the bow grip and check “feel” by pushing out slightly with the bow arm.
- Raise the bow arm and drawing arm together, up to the position.
- Keep the front shoulder in its normal low position (Don’t allow it to rotate up or back)
- Keep the elbow of the drawing arm high (but comfortable!)

### 4.4 The Draw and “anchor”

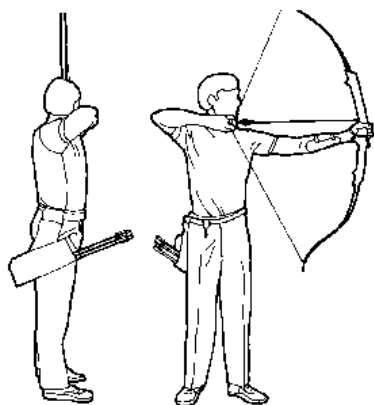

Keep the front arm fully extended, but not over extended (there should be little or no room to “push” from the bow arm) as you draw in a smooth flowing motion in as direct a line as possible all the way back to the “anchor” position.

I’m enclosing the word “anchor” in quotes here because it indicates something solid and immovable, whereas quite the opposite is true – the anchor is in fact simply a transition point between draw and follow-through

Draw the string straight back whilst maintaining a relaxed drawing arm – in this way, the arm will be moved by the powerful back muscles. Using the back muscles is an excellent way to develop consistency and stamina. Using the arm muscles will cause fatigue and result in an inconsistent release

and follow through.

Don’t move the head or body during the draw (remember, the line was developed during the stance phase).

The elbow of the drawing arm should be in line, or slightly higher than the line of the arrow. Check this in the mirror, or ideally, by making a video of your shooting – a video can be invaluable in diagnosing form problems. Having “good line” makes the shot and follow-through much more consistent.

The “anchor” position is where the hand is positioned on the jaw and the bowstring touches the face and should provide a consistent point of reference. Some archers bring the string back to the centre of the chin, others slightly to the side however, there are some do’s and don’ts:

DO lightly touch the tip of your nose with the string.

DON’T bring the string beyond the square of your chin – this may result in the string hitting the chin on its way past.

DO keep your hand close to your neck and remember to keep the back of your hand flat.

DO place the index finger firmly under the jaw to develop a good solid reference point.

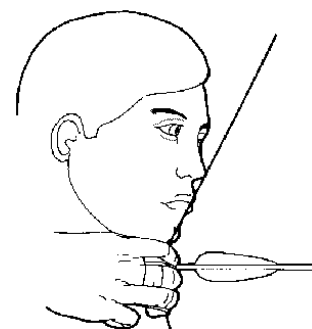

The relationship between all these positions is important as it acts as the rear sight, so it is vital that it be as consistent as possible

Some archers use “kisser buttons”. Small pieces of plastic attached to the string which is placed against the lips, or a tooth. It is important, when using such a device, to ensure that the position on the face, wherever it is, is repeatable. It’s no good anchoring at the corner of your mouth – this can move in all directions, and probably will! Lightly placed between the lips is OK, provided your facial expression does not change too much! Whatever you chose to do, it’s probably best to combine this with a good solid finger or platform under the jaw.

When the string is in place, one final check is important, and that is “String Picture”. This is crucial, especially at long distances. When looking through the sight, you will see a blurred image of the string – it is important that this is aligned to the same point for every shot. If it’s slightly off, rotating your head slightly will correct this. If the string picture is in the wrong place, then your aiming accuracy will be off and the result will be groups which are spread horizontally. For alignment, many European archers use the side or centre of the riser or sight-window, others use the side of the sight aperture – although this method can cause problems when the windage has to be adjusted!

When you get to anchor it is very important that you don’t stop pulling. Changing from a “pulling” action to a “holding” action will make it very difficult to return to the pull, and so the arm muscles are likely to tighten up – this makes it EVEN MORE difficult to pull, and so it becomes very difficult (sometimes impossible) to get through the clicker. If this happens COME DOWN. Don’t struggle – it’ll only make you tired, and may result in a very poor score (even a miss!) if you do manage to get the shot off.

We can draw from the bow all the way back to the anchor, stop and all of a sudden that last 1/16” becomes so very, very difficult. Keep moving, albeit very slowly. The action of pulling, even slightly, will keep the muscles in the “pull” configuration, and suddenly the clicker will be a piece of cake!

Finally – the aim. The answer here is DON’T. This is another concept which will upset beginners... how on earth do we get the arrows near the target if we don’t aim?? Well, quite simply, we do, but not consciously. Let the sight float around the gold. When the clicker goes off, and the release occurs, your brain will automatically centre the sight on the gold... all you have to do is set the shot up correctly, and let your subconscious do the rest.. The following pictures illustrate the result if you’re not dead-centre...

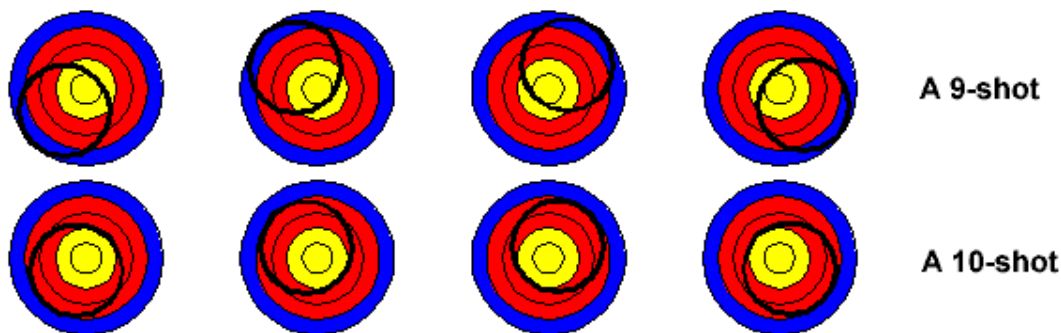

So don’t worry about it!! Look at where you want to hit and focus on movement, focus on line, focus on completion of the shot (NOT the clicker) – whatever works for you.

#### Draw Checklist

- Extend front arm (don’t over extend as this can cause the string to hit your arm)
- Smooth draw to anchor with relaxed arm.
- Front shoulder solid, string back to chin/nose
- Strong hand position under chin, close to neck.
- String picture
- Settle the sight on the gold, but DON’T AIM
- DON’T STOP PULLING

### 4.5 The release and follow-through

As mentioned earlier on, the release (or “loose”) is another critical factor in any shot. A nice relaxed release and continuous follow through will make the difference between an average shot and a stunningly good shot. This is where the “feel” of the shot is all important. It is something we have to learn through many hours of practice. We have to learn to know what a good shot feels like, and then (and only then) can we begin to develop a rhythm and consistency.

Maintain the pulling movement. This takes commitment to the shot. When that bow is up, and the gold is in the sight, either go for the shot wholeheartedly or come down. NO half measure is good enough. If you’re not committed to the shot then only luck will make it a good one.



But don't forget that solid front arm. Don't allow the front shoulder to rise – focus on the gold. Reach for the target whilst continuing the motion. Feel the balance between the front arm and the back arm. Note we say “reach” here – remember that the arm is locked, and the shoulder down so there is very little movement available. Simply strengthen the line, in the direction of the target.

Maintain a relaxed draw hand and arm – don't forget about those back muscles – the forearm and biceps should be as relaxed as possible.

As you continue to pull back the clicker will click. This is not the signal to panic! – that kind of reaction will cause an uncontrolled or “explosive” release, resulting in an erratic, unpredictable shot. The clicker is the signal to allow the subconscious to let go... when it is ready, so simply relax and let the shot flow.

If four or five seconds have elapsed since the string reached anchor, COME DOWN. Don't struggle... don't fight, because your mind will be full of images of coming through the clicker... stresses in the body will induce shaking... all of these things will cause the shot to fail. Many top archers have metronome-like timing, and none of them hold for long periods of time. A draw of five seconds is too long.

Some archers have a tendency to look to see where the arrow is going... don't. Anything we do above and beyond shooting at the gold is a distraction. Once the arrow has gone, it is too late. Simply focus on making the perfect shot into the gold – and then you won't have to “peek”... you'll see it land in the middle!

Follow-through Checklist

- Keep reaching for the target with the front arm – feel the balance between “reach” and “pull”.
- Keep pulling with the back muscles (maintain back tension). Commit to the shot.
- Control the clicker – don't let it control you.
- Focus on the gold, all the way through the shot until the arrow is in the target.

## 4.6 The best style

Sorry to disappoint you, but this section does not tell you what is the best style – simply because there isn't one. Every archer shoots differently. Every archer has a different technique, from the way they hold the bow and the string, to the way they follow through... what all top archers have in common is that they can repeat that same technique time, and time, again. Do not try to copy anyone... develop your own style which feels comfortable, and then teach your subconscious, through hours of repetition, what that style feels like. You will see archers on the shooting line who go through all sorts of complicated rituals and movements... ignore them. Shoot with a simple, flowing, comfortable, relaxed style and you will shoot your best.

## 4.7 Concentration (FOCUS)

Focus is extremely important. Staying with the task at hand is difficult for humans. The average person has an attention span of approximately 2-3 seconds, so developing focus is a key feature for all successful archers... from the pre-draw to the follow-through we have to be single-minded, aware of our body and the feel of the shot, but committed to the centre of the target.

When an archer finds a deep focus and concentration, it is a wonderful feeling. It is almost a meditative state, and is often referred to as “being in the zone”, and once there the archer can achieve great things, but like all things in archery, it takes practice and determination, and even then rarely stays around for long!

When things are going wrong it is easy to get distracted and start over-analysing the shot – and suddenly our minds are full of negative images and self-condemnation. If you get into this state, stop. Put the bow down and relax, because nothing can come from such distracting emotions.

## 4.8 Rhythm and motion

Muscle memory is key to archery, and one of the best ways of developing muscle memory is shooting with a consistent rhythm in continuous motion, and repeating this process over and over again for as many arrows as you can realistically shoot. A good consistent rhythm will provide a strong consistency to the entire shot process. Developing rhythm and motion is best done without a target face... a

technique which is generally regarded as extremely useful. Every archer should have a “rhythm” session at least once or twice a week.

Remove the sightbar, stand close to a boss and simply shoot arrows. Don’t think about the aim – simply ensure that each and every shot FEELS right, and shoot every arrow with focus and commitment. Try to develop a rhythm and try to maintain that rhythm for as many arrows as you can... Concentrate on the feel. Concentrate on the form. And enjoy the feeling of shooting just for the sake of it. This, more than anything, can develop consistency.

Can’t shoot when you’re at home? Simple. Buy/borrow/make a Formaster<sup>®</sup>-type device. This device consists of an elbow cup (or straps) with a cord (elastic or solid) which effectively attaches your elbow to the string. Using this device and a reasonably long hallway (or garden) you can practice pre-draw, draw, anchor and clicker control without risking damage to arrows or property! Simply draw through the clicker, hold for a few seconds and let the arrow down gently without letting go. Even if you DO let go, the Formaster<sup>®</sup> should be set so that the arrow will do no damage and will not be damaged itself.

## 5 Solving Problems

### 5.1 Lost the feel

Many archers have experienced it – one day you are soaring on a high of superb scores, the next, you couldn’t hit a barn door at twenty paces. What do you do? Keep struggling, with dogged determination? Give up? Worry? Get angry with yourself?

**NO.** Go back to basics. Make a check list of your weaknesses, the points on which you feel you need to concentrate. Take the sight off the bow and follow the notes in “rhythm and motion” section. Throw away all those bad habits you’ve developed and go back to the beginning. Archery isn’t difficult, so apply the KISS principle (Keep It Simple, Stupid). Above all, lower your goals... things aren’t going well, and striving to reach impossible targets (Sic.) will only frustrate and annoy you. Start off slowly and you will soon be back shooting the way you know you can.

### 5.2 Target panic

An eternal problem for archers of all disciplines, and one for which there are many causes and no easy solutions. This is sometimes referred to as “Gold Shyness” and some of the symptoms, in order of severity, are:

- Unable to hold the sight on the gold through the shot.
- Unable to prevent release when on the gold or when the clicker drops.
- Unable to get the sight near the gold.
- Unable to achieve full draw.

Occasionally, an archer will go through all of these stages as the symptoms become worse. And of course, the knowledge that there is a problem only increases the fear and uncertainty. Target panic is a psychological problem which stems from a lack of confidence and is a very real problem for many archers.

There are several approaches to overcoming this particular problem, depending on the individual:

- Go back to basics. Pick up a beginners bow, some old arrows, stand near a blank boss with no target face on it and simply shoot arrows. Anywhere on the boss. Don’t try to shoot groups. Get rid of clickers and sights and other gadgets.
- Shoot with eyes closed. (yes, seriously) Stand close to the boss, close your eyes and simply draw the bow. Opening your eyes for the first couple of shots is a good idea to ensure that the position is right. Concentrate on the feel of the shot. Be aware of your body and how it reacts throughout the process. Concentrate on a smooth flowing rhythm.
- When you’re comfortable shooting with these two methods, add a sight and a full-size target to the boss and gradually, over a period of weeks, reduce the size of the face and the distance to the target.
- Get a Formaster<sup>®</sup> and use that when shooting at the target. This will improve confidence since no matter WHAT you do – good or bad, the arrows will end up on the ground and no damage will be done.

There are other methods including distraction techniques, but for these you need to find yourself a good coach.

Finally, don't give up. It can be a long up-hill struggle, but it is not insurmountable and, on the positive side, may make you a much better archer at the end of the day.

## 6 Training

There are many training methods available and a good coach should be able to define an appropriate set of exercises, but the following is intended as a good basic foundation.

### 6.1 Physical Training

#### 6.1.1 Using the formaster<sup>®</sup>

The Formaster<sup>®</sup> device is perfect for training when you can't get to a shooting range, and I use mine in the following ways: (remember – **always warm-up first!**)

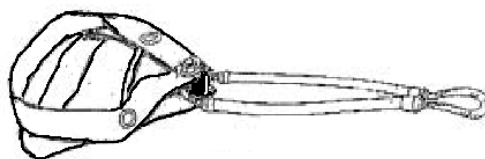

#### Reversals

I've found this exercise excellent for building strength and endurance, and also for helping me find and remember "back tension".

Attach the Formaster<sup>®</sup> to the string near the nocking point and using your ELBOW only (i.e. do not hold the string with your fingers) draw the bow to full draw. Hold for 30 seconds. Release and relax for 30 seconds.

Repeat this as often as is comfortable. If you should start shaking at full draw, stop – this is NOT an endurance test!

For those who are new to this exercise, use a shorter holding time (say 10-20 seconds) and gradually build up as strength increases (once you can do 10 repetitions at a particular duration comfortably, increase the duration).

Repeat this exercise at least once or twice a week (preferably every day on which you do not shoot). After two to four weeks you should be able to repeat the 1-minute draw/relax cycle 10 times. If you cannot, then you may be over-bowed (i.e. using a bow which has too heavy a draw weight). Once you can do 20 repetitions of the 30-second cycle, you are beginning to get strong enough to control your bow effectively – at this stage, you might consider moving on to reversals using heavier limbs.

Once you have started your reversals, you may find it helps to flex the shoulder muscles in small, repetitive movements (i.e. pushing the bow shoulder out and down, and the drawing shoulder round and back.) in order to promote flexibility and movement as well as build strength in some of the smaller muscles.

Remember: STAMINA CAN BE GAINED AND MAINTAINED, BUT NOT STORED

**IMPORTANT** Things to remember:

- **Always warm up first!** I can't say this too often. It is **CRITICAL**. Always pull to full draw slowly and come down slowly and smoothly – be kind your joints and muscles! It may help to start the draw with a higher than normal bow arm
- When drawing the bow, use your elbow in the sling to pull the string, not your fingers
- Keep your head at 45 degrees to the bow arm and keep your neck relaxed
- Watch your posture! Try to keep a normal shooting stance: stand tall, with your shoulders down and relaxed as much as possible
- Both shoulders and bow arm should be in a straight line
- Breathe gently throughout the exercise – don't hold your breath at full draw

- Whilst at full draw, focus your attention on your bow arm shoulder and your drawing arm elbow and shoulder blade. Feel the tension and muscles and feel the balance (50/50 front and back); we don't want to see your bow arm shoulder creeping up or your drawing arm elbow collapsing!
- Feel that you are expanding/increasing drawing very slowly at full draw rather than just a static hold. This will help you to stop creeping/collapsing at full draw
- When you begin to feel the strain, remember not to collapse as this may result in injury. Come down slowly and calmly, maintaining your posture.

### **Back Tension**

***Note: Perform this exercise in an open area or in front of a target. DO NOT perform this with a heavy bow (>60lbs)***

I've found this exercise excellent for:

Teaching the correct use of the upper back muscles, and promoting balance, b) Training muscle memory, c) Teaching good bow arm follow-through

Stand close to a target butt and put a target pin in the butt to provide a point of reference.

Attach the Formaster® to the string just above the nocking point and nock an arrow.

Draw the bow, sight the target pin and pull the arrow through the clicker, focusing on the aiming point.

Release the arrow as normal. One of two things will happen:

1. The drawing elbow will not move, or may move back slightly. This is good as it means that there was no premature relaxation after the shot, and that the back muscles were being used effectively.
2. The drawing elbow will be pulled forward (collapse). This is bad as it means that the muscles were relaxed too early and there was therefore a poor follow through. It also indicates use of the wrong muscles for drawing.

***Note: This is the most likely outcome the first time you use this technique.***

Repeat this 25 times or more to build muscle memory. This muscle memory lasts for some time, but will eventually fade and so has to be reinforced from time to time. As time goes on, the muscle memory will last for longer and longer periods. Try to combine a routine of shots with and without the formaster.

Things to remember:

- DO NOT use this method with bows which are too heavy for you, especially not > 60lb.
- Always check the cord and elbow sling for signs of wear. Replace if you can see any damage

### **6.1.2 Using the bow without shooting**

#### **Clicker Practice**

***Note: Perform this exercise in front of a target.***

I've found this exercise excellent for:

Building strength when I can't shoot, b) Promoting good clicker control, c) Ensuring the clicker is in the correct place, d) Ensuring I am not pinching the arrow

Stand close to a target butt (just in case!) and put a target pin in the butt to provide a point of reference.

Nock an arrow.

Draw the bow, sight the target pin and pull the arrow through the clicker, focusing on the aiming point.

Repeat as necessary.

Things to remember:

- DO NOT let go of the arrow when the clicker goes off.
- Make sure that the sight ring stays near the sight point after the clicker has dropped (i.e. no flinching occurs)
- Try to ensure you maintain tension when the clicker has dropped, and that the tension is directed at the aiming point
- Ensure the arrow does not drop off the rest either before, during or after the draw and release.

Repeat as above, but watch the clicker. Observe the smooth and progressive movement of the point under the clicker. Be aware of the motion of your arms/shoulders as you draw the arrow back smoothly.

### **6.1.3 Using the bow**

#### **Double clicker**

*Note: Perform this exercise in front of a target.*

Attach a second clicker to your bow under your normal one, and position it 1mm closer to the target. Stand close to a target butt (just in case!) and put a target pin in the butt to provide a point of reference. Nock an arrow.

Draw the bow, sight the target pin and pull the arrow through the clickers.

Try to maintain your physical and mental activity between the two clickers.

Repeat as necessary with and without the double clicker

#### **Pyramid shooting**

*Note: Perform this exercise in front of a target.*

Warm up, including shooting at least 18 arrows.

Shoot 4 arrows, holding each one for 5 seconds before release.

Repeat this, varying the number of arrows and duration of the hold as follows:

Arrows	Hold	
3	7 seconds	
2	10 seconds	
1	15 seconds	
2	10 seconds	
3	7 seconds	Try to ensure the clicker drops as close as possible to the time shown.
4	5 seconds	
4	6 seconds	
3	10 seconds	
2	14 seconds	
1	20 seconds	
2	14 seconds	
3	10 seconds	
4	6 seconds	

Over the weeks, increase the times up to a hold of 30 seconds for one arrow.

### **6.1.4 Other exercises for archers**

#### **6.1.4.1 Warm-ups / stretches**

Warm-ups must always be the FIRST part of shooting preparation. If you see someone shooting who has not warmed up, NAG them into it.... The following exercises are a good start: (DO NOT STRAIN... these are stretching exercises only). Don't "bounce" these movements, simply move gently into position and hold.

First of all, do a couple of minutes of vigorous activity to get your pulse rate up and generally warm up the body, such as running or jumping on the spot, skipping, etc.

#### **The Hug**

Wrap your arms around you and hold your right shoulder with your left hand and vice-versa. Hold for a count of 8.

#### **The Shrug**

Raise your shoulders as high as they will go, hold for a count of 2. Relax for a count of 4. Repeat 4-6 times

#### **Rotating Shrug**

With arms relaxed, rotate your shoulders in a circle several times (8-10 repetitions). Reverse the rotation and repeat.

#### **Horizontal Shoulder Stretch**

With your left arm horizontal, bring your left palm over your right shoulder. With your right hand, pull the left elbow towards you and hold for a count of 8.

Repeat for the other arm.

#### **Vertical Shoulder Stretch**

Raise your left arm up and place your left hand between your shoulder blades. With your right hand, pull your left elbow to the right and hold for a count of 8.

Repeat for the other arm.

#### **Rear Arm Stretch**

Place your left arm behind your back with the left hand at your right side. Clasp your left hand with your right hand and pull gently. Hold for 8. Repeat for the other arm.

#### **The Vertical Arm Stretch**

Clasp both hands and stretch arms upwards. Rotate hands until palms of hands face upwards. Push upwards. Hold for 8.

#### **Arm Circles**

Hold both arms vertical. Swing arms in large circles, both in the same direction.

Repeat, but swing left arm forward and right arm backward. Repeat, but swap arms.

#### **Trunk Twists**

Lift both arms out sideways and twist at the waist to the left, then to the right... repeat 3 or 4 times.

#### **Neck Stretching**

Looking straight ahead, tilt head over to left and hold for a count of 8 – repeat for the other side.

Turn head to the left as far as is comfortable. Hold for a count of 8 – repeat to the right. **DO NOT OVERDO THESE**. Great care must be taken to avoid damaging the delicate neck muscles and nerves.

#### **Warming the shooting muscles**

Using rubber bands (clini-bands, inner-tubes, etc.) You can stretch the drawing muscles in a similar way to using a bow.

### **6.1.4.2 Basic fitness**

Good basic health is a good start for archers, so simple walking, cycling and jogging to improve cardiovascular and leg fitness is a good idea. Push-ups are good for building upper body strength, but too much arm muscle-mass is a bad idea.

## **6.2 Mental Training**

### **6.2.1 Imagery**

When you can't shoot arrows in reality, it's good to shoot arrows in your mind. Sit in a well-supported position in a quiet room, and simply shoot arrows. Visualise the shot from inside and from outside. See yourself shooting perfect arrows into the 10-ring. **DO NOT DO THIS WHILST DRIVING!** This is a good exercise for lunch-break at work.

This can also be done whilst carrying out the motions with your upper body. Feel the draw, the anchor and the release. Feel the constant motion and watch the imaginary arrow land in the imaginary 10.

### **6.2.2 Positive Self-talk**

Even when shooting, we can prepare and enhance our mental state, simply by being less negative and self-destructive. It has been said that self-talk is 60 times more effective than actual experience. Get rid of words like "can't", "won't". Replace them with "can" and "will".

"I can shoot better than that" is much more positive than "that was rubbish".

"I know I can do this" is much better than "I'm struggling with the clicker"

Don't talk down a bad shot, or worse still, analyse it! The only thing we learn from analysing bad shots – is how to shoot bad shots!... Analyse the good ones, and remember what made them good shots. Don't discuss the poor shots with others, instead, talk about the good shots.

Build your own confidence and self image, and your performance will improve.

## 7 Types of archery

### 7.1 Target

Target archery is one of the oldest forms of archery. Since man first strung a bow, he has been shooting at targets to improve his hunting skills. Modern target archery is a year-round sport, consisting of shooting at a round target face split into 5 or 10 scoring zones, usually coloured yellow, red, blue, black and white.

In the UK, Imperial outdoor rounds use a 5-zone face and are scored 9 for yellow, 7 for red, 5 for blue, 3 for black and 1 for white. Metric rounds use a 10-zone face scored 10 for inner yellow, 9 for outer yellow, 8 for inner red, 7 for outer red and so on.

There are many indoor and outdoor rounds varying mainly in the distance shot, the number of arrows and the size and type of face.

Common indoor rounds are:

Round	#arrows	Distance	Face
FITA 18m	5 dozen	18m	40cm – 10-zone
Bray I	2.5 dozen	18m	40cm – 10-zone
FITA 25m	5 dozen	25m	60cm – 10-zone
Portsmouth	5 dozen	20yards	60cm – 10-zone
Vegas	5 dozen	18m	20cm with only five scoring zones – 10,9,8,7,6

Common outdoor rounds are:

(IMPERIAL) - #dozen arrows at each distance.

Face	122cm 5-zone				
Round	100yds	80yds	60yds	50yds	40yds
York	6	4	2		
Hereford / Bristol I		6	4	2	
St. George	3	3	3		
Albion		3	3	3	
Windsor			3	3	3
American			2.5	2.5	2.5

(METRIC) - #dozen arrows at each distance.

Face	122cm 10-zone			80cm 10-zone		
Round	90M	70M	60M	50M	40M	30M
FITA (gents)	3	3		3		3
FITA (ladies) / Metric I		3	3	3		3
Long Metric (g)	3	3				
Long Metric (l)		3	3			
Short Metric				3		3

Gents FITA is the international standard by which target archers are judged.

#### 7.1.1 Basic Competition Rules

##### 7.1.1.1 Equipment

Equipment will be checked prior to the start of shooting. The following checklist provides a basic guide to the main points for the recurve bow:

- No marks are allowed on the inside of upper limb as these may be used for aiming.
- No aiming devices or marks on the string. The string serving must end below eye level when at full draw.
- Arrows must be marked with name, initials or insignia. Arrows must carry the same fletching colours/nock colours.

- Face of tab must be smooth – no hooks or other holding devices.

### 7.1.1.2 General Rules

- Be silent whilst on the shooting line. On no account speak to other archers.
- Spotting scopes may be used, but may not be left on the shooting line between ends.
- Do not touch another archer's equipment without their permission.

### 7.1.1.3 Shooting Order

A competitor list will be posted and will give each archer a target number and a letter. Target numbers are shown beside each target and on markers on the shooting line.

Usually there are no more than four archers per target (designated A, B, C and D) and no fewer than two. Usually only up to two archers will shoot simultaneously on the same target.

A and B will shoot together, C and D will shoot together. A and C shoot on the left of the line marker, B and D shoot on the right. Each set of archers going up to the line is termed a "wave" i.e. First wave = A/B. Second wave = C/D.

Archers A and B will shoot first, followed by C and D. At the next end, the order will reverse and C and D will shoot first. There will be a board/sign indicating which archers are first to shoot at the next end.

If there are four faces on the target: A shoots top left, B shoots top right, C shoots bottom left, and D shoots bottom right.

If there are three faces: A shoots bottom left. B shoots top centre, C shoots bottom right

### 7.1.1.4 Shooting

Do not raise your bow arm too high. If the judge thinks that you could perhaps overshoot the safety area if you let go of the arrow, then you will be warned and, if you persist, disqualified.

### 7.1.1.5 Scoring

- DO NOT TOUCH any arrows or the target face until the scores have been recorded.
- Point to the nock of the arrow whilst calling out the score. Call out the scores highest arrow first in groups of three. E.g. "9, 9, 7" <pause> "6,2,miss"
- You must not record your own scores. Usually one of A/B will score for C/D and vice versa.
- You must check the scores as they are written down.
- Changes to the scores must be made and signed by a judge. Changes to the totals may be made by the scorer.
- In Metric rounds, mark the face with a line drawn directly towards the arrow shaft before drawing the arrows.

#### Special Marks:

X = Inner 10 in all outdoor FITA rounds.

M = Miss

At the end of the competition, remember to sign the score sheet to indicate that you agree with the scores.

### 7.1.1.6 Bouncers

If an arrow bounces out of the target, stop shooting, take two steps back from the line and raise your bow to attract the judge's attention.

### 7.1.1.7 Unshot arrows

An arrow is deemed to have been unshot if it can be reached with the bow, without moving from the shooting line. It may be retrieved and shot.

### 7.1.1.8 Etiquette

- Do not leave the shooting line if your target partner is in the process of drawing the bow.



- Keep noise to a minimum behind the waiting line when archers are on the shooting line.
- Do not collect missed arrows until the scoring is complete.

### 7.1.1.9 Outdoor Competitions

There will be a shelter line, a waiting line 5m in front of that and a shooting line 5m in front of that.. All archers not shooting must stay behind the waiting line. Equipment (bows, scopes, etc.) must be also kept behind the waiting line. Shelters, tents etc. Must be kept behind the shelter line.

#### 7.1.1.9.1 METRIC ROUNDS

6 arrows per end are shot at 90m and 70m.

3 arrows per end are shot at 50m and 30m.

Control of shooting is by buzzer/whistle and sometimes lights.

- 1) Two whistles – walk to line. You may nock an arrow, but you may not raise your bow arm at this time.
- 2) Single Whistle – begin to shoot (leave the line when you've shot all arrows for this end)
- 3) Two whistles – end of shooting. Leave line (if you haven't already done so)
- 4) Each wave repeats 1-3 until all waves have shot.
- 5) Three whistles are sounded to go and score/collect arrows.

Time Limit: 2 minutes to shoot 3 arrows or 4 minutes to shoot 6 arrows.

When lights are used, a green light indicates that shooting has commenced. An amber light indicates that 30 seconds shooting time remains. A red light indicates that shooting must cease.

#### 7.1.1.9.2 IMPERIAL ROUNDS

6 arrows per end at all distances

Shoot 3 arrows, retire, then when other waves have shot, shoot another 3. Then all collect their arrows.

- 1) First whistle –
- 2) walk to line.
- 3) Shoot 3 arrows
- 4) Leave line
- 5) Wait for other archers to shoot their 3 arrows
- 6) Repeat 2-5
- 7) Finally two whistles to go and score/collect arrows.

### 7.1.1.10 Indoor Competitions

Control of shooting is by buzzer/whistle and occasionally lights.

- 1) Two whistles – walk to line. RED light.
- 2) Single whistle – shoot. GREEN light. Leave the line when you've shot all arrows.
- 3) Amber light lights when 30 seconds are left for end of shooting.
- 4) Two whistles – end of shooting. RED light. Leave line (if you haven't already done so)
- 5) Repeat 1-4 until all waves have shot.
- 6) Three whistles to go and score/collect arrows.

Time Limit: 2 minutes to shoot 3 arrows or 4 minutes to shoot 6 arrows.

### 7.1.1.11 Common Mistakes

- Forgetting to mark arrows with initials.
- Drawing the bow before the second whistle.
- Touching or drawing arrows before scoring.
- Forgetting to mark the face.
- Shooting too many arrows.

## 7.1.2 Competition Preparation

There is more to competition preparation than simply honing your form and technique to perfection. The final stages of tournament preparation should begin at least the night before the shoot – MAKE A LIST and CHECK YOUR EQUIPMENT.

### 7.1.2.1 Making a list

Make a list of everything that you need to take with you, most important things first. Preferably, use the same list for all competitions, that way you can add anything you've forgotten.

A list for a shoot might look something like this:

#### Indoors:

- |                             |                                  |                   |
|-----------------------------|----------------------------------|-------------------|
| 1. Bow.                     | 9. Bracer.                       | 14. Arrow puller. |
| 2. String.                  | 10. Chest Guard.                 |                   |
| 3. Spare String(s)          | 11. Association membership card. |                   |
| 4. Arrows.                  | 12. Repair kit.                  |                   |
| 5. Sight/Button/Stabilisers | 13. Spotting scope and stand.    |                   |
| 6. Quiver.                  |                                  |                   |
| 7. Tab.                     |                                  |                   |
| 8. Finger Sling.            |                                  |                   |

#### Outdoors add:

15. Food & Drink
16. Tent/chair.
17. Tent pegs/hammer.

#### And depending on the weather:

- |                 |                |                        |
|-----------------|----------------|------------------------|
| 1. Gaiters.     | 3. Hat/Gloves. | 5. Sun Visor / Glasses |
| 2. Waterproofs. | 4. Sun-cream.  |                        |

### 7.1.2.2 Equipment checklist

Going through your equipment checklist will help avoid any nasty surprises. An example checklist might look like this:

- |  |   |  |
|--|---|--|
| <input type="checkbox"/> Riser is undamaged                      | <input type="checkbox"/> Fletchings are secure and in good condition. | <input type="checkbox"/> Sight mounting is secure.           |
| <input type="checkbox"/> Limbs are undamaged.                    | <input type="checkbox"/> Points and nocks are secure.                 | <input type="checkbox"/> Tab and finger sling are undamaged. |
| <input type="checkbox"/> String is undamaged and is waxed.       | <input type="checkbox"/> Button is clean and moves freely.            |  |
| <input type="checkbox"/> Arrows are marked with number/initials. |   |  |

## 7.2 Clout

The purpose of clout archery is to place an arrow in the ground close to, or in, the "clout". The clout is most often represented by a post or flag. Score is determined by the distance of the arrow from the flag: 18 inches = 5 points. 3 feet = 4 points. 6 feet = 3 points. 9 feet = 2 points. 12 feet = 1 point.

A clout round consists of 3-dozen arrows at various distances depending on the archer: Gentlemen: 9-score yards. Ladies: 7-score yards, and so on.

## 7.3 Field

(Thanks to Tim Goodwin for most of the text and insight for this section).

Field archery stems from hunting and is great fun, it is also a great way for new archers to get used to longer distances associated with outdoor shooting. Rather than being thrown in at the deep end and being forced to shoot 90/70m straight away, you can learn to cope with distances below 60 meters, that can be reached comfortably with even the lightest of recurves. Field archery is good for the more experienced archers too, as it will teach you a degree of flexibility with your shooting style and also is often a good break from the drudge of target shoots which you do week in week out.

So what is it? Well, field archery is similar to target archery, but you must follow a course through often wooded and uneven terrain. Targets are set out between 10 and 60 meters and depending on the round, distances may be marked or unmarked.

There are typically 48 targets over 2 days (24 each day), it is common to shoot all the unmarked targets on the first day and the marked on the 2nd day. I can already tell that you are questioning the 'unmarked' term, this means that the distances are unknown, and before you all disappear it really is not as daunting as it sounds. In fact you will generally score better on the unmarked targets as they are often set at shorter distances, there are also ways of figuring out how far away the targets are, but more on that later...

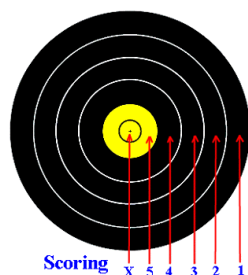

The target faces have a gold spot and four black scoring rings, the diagram on the below shows the scoring zones. There are four different sizes of face, the 80cm and 60cm faces are just a single target on the boss, the 40cm face is 4 faces on the boss, one for each archer, and finally the 20cm face is a sheet with 12 targets, in 4 rows of three (very much like the three spot fita faces you shoot indoors), this target is usually called the 'bunny' face.

At the beginning of a shoot you are given a target number assignment, this is the target that you will start shooting from, along with 3 other archers. At the morning assembly you will be led out to the target by one of the field party.

You shoot three arrows at a target and then move forward to the target to score once all archers in your group have shot their three arrows, it is often courteous to spot for a fellow archer who is shooting while you are not. The position from which you shoot from is marked by a single peg, which you must stand behind. There are in fact two pegs, one is red and the other is blue. The red peg is for recurve and compound archers to shoot from, the blue peg is for barebow/longbow archers to shoot from, this peg is generally closer than the red peg.

#### **What do I need for a field shoot?**

Below is a short list of essentials for a field shoot, they are in no particular order except the first one which is essential for your own sanity and enjoyment.

- A really good solid set of sight marks, between 10 and 60 meters in 5 meter intervals. I would also suggest marking them on your sight bar as well as on a piece of paper in your pocket. If you are certain of your sight marks everything else will come easy.
- A good solid (waterproof) pair of walking boots and an umbrella. An umbrella is useful for three things, keeping dry if it rains, as a temporary bow stand and a really handy walking stick for getting up trickier slopes.
- Something to drink.
- A light snack to eat.
- A pocket full of change, this is to buy some snacks at the tea stops and also to buy your target companions a cuppa as well.
- The same archery equipment you use for target archery, including the same arrows you would normally use, take at least 8 with you on the course.

#### **Unmarked distances are not completely unknown.**

The one reason... no... excuse most often given for not wanting to do FITA field is the unmarked targets. To be honest with you I thought the same before I did any field, but when I found out a few simple rules and a couple of sneaky tricks, unmarked distances certainly became more hit, and less miss. Firstly unmarked targets can only be set within a given range. A 80cm target can only be between 35 and 55 meters for instance, so as long as you know it is an 80cm face you have already narrowed the range to within 20 meters, the difference between a 35m target and a 55 meter target is very obvious so just by looking at the target you can very quickly get it down to within a 10 meter range, this is essentially 'guessing' the distance and you are already within range of keeping an arrow on the boss (ie. +/- 5 meters). The 80cm face is really the hardest target on the unmarked round and it is clear that you are more than likely to hit the boss at the very least.

There are often other clues to working out what the distance is. By looking at surrounding objects you can quickly get a feel for distance. For example, if a target is placed down a row of trees, you can easily gap the distance between each tree, a common clue is in a plantation of trees, the gap is usually exactly five meters between each tree, count the gaps and you know the distance. The more field archery you do the more you get a feel for distance, and well practiced at distance estimation.

There are other ways of more accurately working out the distances but it is best to leave these techniques until you have completed at least two or three field shoots.

And that's all there is to it really!

## 7.4 Popinjay (Papingo)

Popinjay archery consists of shooting up at a "roost" of "birds". There is a cock "bird" (5 points), four "hens" (3 points) and a minimum of 24 "chicks" (1 point). Cocks are 10-12" high and situated 90 feet above the ground. Hens are 6-8" high and situated 89 feet above the ground. Chicks are 3-4" high and situated from 80 to 88 feet above the ground.

Arrows with blunts are used and only one arrow is shot at each end. A bird must be struck with the arrow and fall to the ground to score. Rounds may consist of a number of arrows, or may be defined by time.

## 7.5 Flight

The purpose of flight archery is to shoot an arrow as far as possible. Distances are marked from 150 yards at intervals of 50 yards often to over 1000 yards. Typical equipment used may either be standard target bows or specialised flight bows.

There are usually at least four ends of three arrows shot.

## 7.6 Other rounds

**Archery Darts** is shot with a 76cm darts face at a distance of 15 yards or more. Scoring is as in normal darts.

**Archery Golf** is shot on a golf course towards a 4" cardboard disc on the green. Rules are similar to normal golf.

There is one other round is worthy of mention, if only for its ability to test archers of all levels. A fun round called the "**masters**" round, which has also been called the "**easter egg**" round in some places is a novelty shoot – there are no classifications, no handicaps and the rules are simple.

Nine targets are set out at 60 metres, 50 metres and 40 metres. At each distance, three targets are set up with one of each of the 122cm face, the 80cm face and the 40cm face. The distances are mixed such that no two adjacent targets are set at the same distance,

e.g.	target 1:	60 yards, 60cm	target 2:	50 yards, 122cm	
	target 3:	60 yards, 80cm	target 4:	40 yards, 60 cm	etc.

Archers pick a target number from 1-9 at random and that is where they start the round. Each archer shoots two three-arrow ends, and then moves on to the next target. When all 9 targets have been shot, the process is repeated.

There may be spot prizes e.g. best gold, worst white, closest score, etc. throughout the shoot.

# 8 Modern History (the last 30 years)

## 8.1 The Olympics

The Olympics are the aspiration of athletes world-wide but Archery has not always been a part of the Olympics. Archery was introduced to the Olympics in 1900 and was also a part of the Olympics in 1904, 1908 and 1920. Various kinds of archery competition were on the Olympic program from 1900 through 1920. The exact type of competition depended on the host country. The United States, in 1904 and England in 1908, favoured target archery. Countries on the European continent, though, favoured more exotic kinds of competition, usually more closely associated with hunting.

In 1900 in Paris, rounds called "Au Cordon Dore" and "Au Chapelet" were shot. 1904 (USA) and 1908 (London) saw the York, Columbia, American and National rounds whilst in 1920 (Belgium) archers were shooting at moving and fixed bird targets in the true Papingo fashion!



Ladies competing in 1908 with the Longbow. Mr. Graham O’Neil informs me that in these days, a target range used to have targets at both ends of the field. You shot at one, collected your arrows, turned around and shot back the other way. Saved a lot of walking, especially for the delicate Victorian ladies! It is also the origin of the term an “end”. You shot from one end and then the other, with one dozen being made up of two ends. Sounds like a great idea, but could make for interesting windage adjustments!

International rules had not yet been developed and each host country used its own rules and format. Because of the resulting confusion, the sport was eliminated from the Olympic program when the International Olympic Committee took control of medal sports.

FITA was founded in 1931, implementing standardised rules for competition which allowed the first World Championship to be held that same year. Archery was reintroduced to the Munich Olympics in 1972 after enough countries had adopted FITA’s rules.

Since 1972, the United States has won every Olympic men’s individual gold medal except for 1980 (the U.S. boycott year) and 1992.

### **Individual Results**

<b>Year</b>		<b>Gents</b>	<b>Ladies</b>
1972	Gold Silver Bronze	John Williams (USA) Gunnar Jervill (SWE) Kyösti Laasonen (FIN)	Doreen Wilber (USA) Irena Szydłowska (POL) Emma Gapchenko (URS)
1976	Gold Silver Bronze	Darrell Pace (USA) Hiroshi Michinaga (JPN) Giancarlo Ferrari (ITA)	Luann Ryon (USA) Vaneltina Kovpan (URS) Zebiniso Rustamova (URS)
1980	Gold Silver Bronze	Tomi Poikolainen (FIN) Boris Isatchenko (URS) Giancarlo Ferrari (ITA)	Ketevan Losaberidze (URS) Natalya Butuzova (URS) Päivi Meriluoto-Aaltonen (FIN)
1984	Gold Silver Bronze	Darrell Pace (USA) Richard McKinney (USA) Hiroshi Yamamoto (JPN)	Seo Hyang Soon (KOR) Li Lingjuan (CHN) Kim Jin-Ho (KOR)
1988	Gold Silver Bronze	Jay Barrs (USA) Park Sung Soo (KOR) Vladimir Esheev (URS)	Kim Soo Nyung (KOR) Wang Hee Kyung (KOR) Yung Young-Sook (KOR)
1992	Gold Silver Bronze	Sebastien Flute (FRA) Chung Jae Hun (KOR) Simon Terry (GBR)	Cho Youn Jeong (KOR) Kim Soo Nyung (KOR) Natalia Valejeva (EUN)
1996	Gold Silver Bronze	Justin Huish (USA) Magnus Petersson (SWE) Kyo-Moon Oh (KOR)	Kyung-Wook Kim (KOR) Ying He (CHN) Olena Sadovnycha (UKR)
2000	Gold Silver Bronze	Simon Fairweather (AUS) Victor Wunderle (USA) Wietse van Alten (NED)	Mi-Jin Yun (KOR) Nam-Soon Kim (KOR) Soo-Nyung Kim (KOR)

## Team Results

<b>Year</b>		<b>Gents</b>	<b>Ladies</b>
1988	Gold	KOREA	KOREA
	Silver	USA	INDIA
	Bronze	GREAT BRITAIN	USA
1992	Gold	SPAIN	KOREA
	Silver	FINLAND	CHINA
	Bronze	GREAT BRITAIN	EUN
1996	Gold	USA	KOREA
	Silver	KOREA	GERMANY
	Bronze	ITALY	POLAND
2000	Gold	KOREA	KOREA
	Silver	ITALY	UKRAINE
	Bronze	USA	GERMANY

## 8.2 Equipment History

### 8.3 Modern equipment comes of age

Between 1970 and 1989, many major development happened in rapid succession, driving up scores and equipment reliability.

In the early 70s, John Williams was the first to use three stabilisers out in front of the bow. Before that everyone used either top/bottom rods or a long-rod. This was due to the new innovative side mounts of sights. Before this, everybody mounted their sights on the front or back . John shot a 1268 world record at the 72 Olympics with XX75s and NO plunger button.

Darrel Pace (the first person ever to shoot a 1300) was never afraid to experiment either. He used Kevlar an a V-Bar for the first time in 1975 at the World Championships. He was one of the first top archers to use a ledge tab, and used it to good effect in the '76 games, also shooting the first cabon/wood limbs.

He went on to shoot a truly astounding world record 1341 in 1979 with a Hoyt GM T/D2. The story of the 1341 goes like this: A family member had died before the tournament and he hadn't shot in quite a long time. He'd got some new equipment in just before he and Rick McKinney left for the tournament and he had no sight settings. He just took his old sight, set it beside his new one and copied over sight marks. He and Rick got held up at an airport on their way to the tournament and had to travel all through the night the evening before. When they got to the tournament, they had no sleep and only one end of practice left. His first practice arrow missed the target at 90, and his last was a 9. After that he had to guess where to put his sight for the rest of the distances. Both Darrel and Rick shot World Records at 90m. Rick and Darrel both finished with new World Records, but Darrel's was higher. Rick got his own back in '92 setting a new world record with 1352 (again, with a Gold Medallist).

In the Mid 80s, Fast Flight saved limbs and risers as the previously used Kevlar only lasted around 1000 shots.

1983, Easton introduced the A/C arrow and it was the first time that 2600 was shot at the World Championships, with the top 3 archers all achieving this feat!

1986 Beiter introduced the legendary Beiter nock.

1987 the Koreans began their drive for world domination with Beman arrows.

1988 Easton introduced the ACE, and Jay Barrs used it on his way to Olympic gold.

### 8.3.1 Hoyt

Hoyt's range of "Modern" bows began in 1972 with the development of a bow limb take-down system that accurately positioned, aligned and locked-in the bow limbs. The majority of bows at that time were still one-piece wooden bows. During the next four Olympic Games, the Hoyt line of bows never failed to win a gold medal, plus silver and bronze. Also, since 1959, Hoyt has won more gold, silver and bronze medals in International (FITA) and National (NAA) competitions than any other brand

Pro Medallist T/D (1972) – A major breakthrough in riser design. Developed in 1972 and used by both John Williams and Doreen Wilber in that year – the start of Hoyt's rise to fame. There were ten of these bows produced and only the Americans were given them, which caused a bit of a stir amongst the competitors.

Pro Medallist T/D 2 – (1976). Only available in black or white. No tiller adjustment.

Pro Medallist T/D 3 (1980) – A troubled mix between the T/D 2 and T/D 4. Never very successful. Did have tiller adjustment though. Multicoloured variations available.

This was followed by various improvements including the T/D 2B and T/D 3B.

Easton Aluminium purchased Hoyt in 1984 and formed a new company.

Gold Medallist T/D 4 – Developed using high speed film analysis of Jay Barrs bow, resulting in a beefed up bow, eliminating some of the breakage they had been experiencing.

T/D 5 – A Russian made 23" riser for Hoyt. Didn't last long due to disagreements between Hoyt and the Russian manufacturers.

Gold Medallist T/D 4+ – This is the bow you can buy in the shops today! The result of many years of development and further strengthened from the T/D 4. This bow is virtually indestructible and many top shooters still love and shoot their GMs.

Since then Hoyt have gone from strength to strength with the Radian, the troubled Avalon, the Elan, the much improved Avalon Plus, and more recently the new radical look of the Axis and the AeroTec.

## 9 Reference Material

### 9.1 Books

The following list is my own personal recommended reading list and is in no way extensive.

- Archery, steps to success by Kathleen Haywood, Catherine Lewis, Leisure Press.  
An excellent book for beginners and advanced archers together. Probably one of the most comprehensive archery "manuals" I've read.
- The Simple art of Winning by Rick McKinney, Leo Planning Inc.  
A superb read for the intermediate to advanced archer by one of the nicest guys in archery. This book explains it all in fine detail.
- Archery in Earnest by Roy Matthews  
A good solid read. Lots of practical hints and tips and good sections on the mental approach to archery.
- Archery Anatomy by Ray Axford  
If you want to know how the muscles and bones interact, and how to use them efficiently to improve your shooting, then this is the book to read.
- Easton tuning and maintenance guide  
Excellent guide to tuning and equipment from arrow-supremos Easton.

### 9.2 Videos

- Any televised coverage you can record.  
Seriously – Get a hold of any Olympic or world championship coverage and watch how it SHOULD be done. Many clubs will have access to this kind of material.
- Archery – refining your form  
A good introduction to the finer points of shooting.

- Various videos by Jay Barrs and Ed Eliason, I personally own “Tuning practice and execution”, “Advanced Form, Perfecting the Shot” and “Archery’s Most Asked Questions”... all make for interesting watching.

### 9.3 The Internet

The following sites are my own personal surfing haunts, and a good place to go for more information (in order of preference, but they’re all my favourites!)

- <http://snt.student.utwente.nl/~sagi>  
The simply superb Sagittarius web pages. Everything you ever wanted to know about archery, but were afraid to ask! Jam packed full of years of knowledge, home of the “Blackboard” a discussion group frequented by many well-known archers. Searchable database of discussions, usenet archives, you name it... it’s here!
- <http://www.tardis.ed.ac.uk/~ajcd/archery/index.html>  
Angus Duggan’s personal home page. Lots of good solid advice from Scottish Archer, now resident in the USA.
- <http://margo.student.utwente.nl/~stretch>  
John Dickson’s personal home page. More good solid advice on technique and equipment from one of Scotland’s hot-shots.
- <http://www.tenzone.u-net.com/>  
Excellent website by Steve Ellison, UK archer and coach. Lots of useful info on equipment, technique, training and psychology
- <http://www.texasarchery.org/>  
Excellent site – home of the Texas State Archery Association. Packed full of useful information.
- <http://homepage.ntlworld.com/joetapley/>  
What this guy (Joe Tapley) doesn’t know about the physics of archery isn’t worth knowing!
- <http://www.bowsports.com/>  
UK archery supply company. Prompt, reliable, low cost.
- <http://www.quicks.com>  
UK archery supply company. Full catalogue on-line, technical articles and more!
- <http://www.archeryfocus.com>  
The superb US archery magazine. Lots of really good articles from many of the most knowledgeable people in archery, including Rick McKinney, Don Rabska and George Tekmitchov. Some of the articles are available free on-line for a short period of time.
- <http://www.bownet.com>  
Home of UK archery magazine... second only to archery focus!
- <http://www.centenaryarchers.gil.com.au>  
Centenary archers – an Australian club with great pages on tuning, form, equipment and so on. Most of the figures in this document were “borrowed” from this site.
- <http://www.scottisharchery.org.uk>  
The Scottish archery association website.
- <http://www.gnas.org>  
Homepage of the UK’s Grand National Archery Society. All the information on rounds, records, events, news and more.
- <http://www.altservices.co.uk>  
A UK based archery retailer. Sells most things at good prices. Accepts Euros, UK Pounds and US Dollars.
- <http://www.usarchery.org>  
Homepage of the American National Archery Association.
- <http://www.cam.ac.uk/societies/cub/>  
Cambridge University archery club. Lots of interesting information.
- Usenet news groups:  
<news://alt.archery/>  
<news://rec.sport.archery/>  
Home of some of the best (and worst!) advice around... the world of archery, in one place. Search for particular topics using <http://groups.google.com/>



## 10 Glossary of archery terms

Arm-guard	Protective arm covering for bow-arm. Usually plastic, metal or leather.
Bare shaft	An arrow without fletchings.
Barebow	A bow with no sight or aiming devices.
Berger Button	See Button.
Bouncer (Bounce-out)	An arrow which strikes the target and then falls to the ground.
Boss	See Butt.
Bow-scale	Device used to measure the draw-weight of a bow
Bow-square	Device used to measure bracing height and nocking-point position.
Bowyer	One who makes bows.
Brace Height	Distance between string and pivot-point of the bow (or pressure button).
Bracer	See Arm-guard.
Broadhead	Arrow point used in hunting. V-shaped with two or more cutting edges.
Butt	Backstop behind target face, usually straw or foam.
Button	Spring-loaded button. Used to absorb some of the sideways force of the arrow after release.
Cam	Eccentric pulley found on compound bows.
Chest-guard	Protective clothing used to prevent string catching on clothes or body.
Clicker	Metal or plastic device. Produces audible click when arrow is at full draw.
Clout	Archery competition where archers shoot at a peg in the ground.
Creep	Non-recoverable elongation unlike stretch which is basically elasticity or recoverable elongation
Crest	Coloured markings on the arrow shaft.
Compound Bow	Bow with eccentric pulleys and cables allowing high bow weights, but low weight at full-draw.
Cushion Plunger	See Button.
Draw	Pulling the bowstring.
Draw length	The distance between the string and the pivot point at full draw.
Draw-weight	Weight held by archer at full draw.
End	A specified number of arrows (usually 3, 4 or 6) shot between scoring.
Face	Target – usually made from paper or card.
Field Archery	Archery shot in wooded course.
Fishtailing	Movement of arrow from side to side during flight.
Fistmele	Archaic term referring to the Bracing height of the bow (which was often measured by using a fist with the thumb extended)
FITA	Federation Internationale de Tir a L'Arc. International target archery federation.
Flemish twist	The traditional longbow string with the loops made in the same manner as a rope, by twisting and splicing, rather than being a continuous strand of string material with the loops formed by serving. Can be used with recurves, but not recommended.
Fletching	The feathers or coloured plastic “wings” attached towards the rear of an arrow.
Fletching Jig	Device used to hold arrow and fletchings to ensure consistent positioning while the glue is drying.
Flight Shooting	Archery shooting for maximum distance.
Flu-flu	Large spiral fletching designed to slow arrow down quickly.
Foot marker	Device pushed into ground to ensure consistent foot position.
F.O.C.	Front of centre – the balance point of the arrow when the point is fitted.

Gap shooting	Using the distance between the arrow and the target as an elevation gauge.
Gold	Centre of the target (it is often coloured yellow).
Gold shyness / Gold fever	See Target Panic.
Grip	Where hand is placed on riser. Often plastic or wooden.
Group	Several arrows shot close together.
Kisser Button	Small plastic device attached to the string for alignment with mouth at full draw.
Lady Paramount	The lady in charge of an archery tournament. An honorary position only.
Limb	The energy-storing portion of the bow above and below the riser.
Longbow	Single-piece bow. Traditional archery.
Loop	Portion of the string which is strung around the limb tip.
Loose	The action of releasing the string.
Minnowing	High-speed movement of arrow from side to side during flight. (Indicative of poor clearance)
Nib	See Point.
Nock	Plastic device at the end of an arrow in which the string is placed.
Nocking Point	Position on the string at which the nock is located.
Overdraw	Device used to permit archers to use arrows shorter than their normal draw length.
Paradox (archer's paradox)	A seemingly contradictory statement that may nonetheless be true. "Logic" dictates that a straight and balanced arrow must be shot straight at a target in order to hit it. In reality, the arrow must be aimed OFF of the target by a traditional archer in order to hit the target, due to the way the string reacts to the fingers on release.
Peak draw-weight	Maximum weight held by archer whilst drawing the bow.
Pile	See Point.
Pivot-point	Position on grip farthest from the string.
Point	The pointed metal device inserted at the tip of the arrow.
Porpoising	Movement of arrow up and down during flight.
Pressure Button	See Button.
Puller	Rubber mat used to protect hands and provide grip when pulling arrows.
Recurve Bow	Bow with limbs which curve away from the archer.
Quiver	Pouch, usually worn around the waist or placed on the ground, used to hold arrows and other accessories.
Release	See Loose.
Rest	A wire or plastic device on which the arrow sits before and during the draw.
Riser	The handle of the bow.
Serving	Protective wrapping of string material around string to prevent wear.
Shaft	The body of an arrow.
Sight Window	See Window.
Sling	Device to attach bow to archer's bow-hand.
Spine	The stiffness of the arrow shaft.
Stabiliser	Rod and weight combination attached to the bow to eliminate unwanted torque and vibration.
Stacking	Rapid increase in the draw weight of the bow, not in direct relation to the draw length.
String Walking	Used by barebow archers. Fingers moved up and down string according to target distance.
Stringer	Device used to bend the limbs of a bow to allow the string to be attached.
Tab	Protector for string-fingers to prevent chafing.
Target Panic	Affliction where archer cannot hold the sight in the gold.

Toxophilite	Archer.
Tiller	A measure of the balance of the two limbs.
Tuning	Adjustment of the bow and arrow to provide most accurate and forgiving arrow flight.
TFC	Torque Flight Compensator. Device used to absorb vibration.
Vane	See fletching.
Windage	Horizontal adjustment of a sight to compensate for wind-drift.
Window	Recessed area of riser above the grip.

## 11 Acknowledgements

Many thanks go to the following people for their assistance in putting this document together, and for years of advice and guidance:

John Grove for the “making a string” section text and excellent illustrations.

John Robertson for his severe but welcome corrections to my grammar, spelling and technical accuracy... Thanks for taking the time.

Tom Woodley and Graeme Jeffrey of Centenary Archers, Australia for the use of their web pages.

Many of the graphics in this document came from these excellent web sites

Mike Perkes from Easton for the Easton tuning and maintenance guide

George Tekmitchov from Easton for many years of excellent technical advice and guidance.

John Kearney and Richard Priestman for helping me flesh out the reversals exercises.

Rick McKinney and Denise Parker from the simply excellent Archery Focus magazine for allowing me to use the information from the technical articles from their publication.

Simon Oosthoek for putting together and maintaining the SUPERB Sagittarius archery web pages.

John and Emma Dickson (Archery Club of Edinburgh) for putting up with my stupid questions.

Vittorio Frangilli for supplying much advice and research material.

All the other regulars on the Sagittarius Blackboard and the Usenet newsgroups (especially rec.sport.archery)

Rick Stonebraker for allowing me to include his “Tuning for Tens” booklet.

J. Collymore, Graham O’Neill, for additional helpful information.

The late and sadly missed Don Branson, who left us on 24<sup>th</sup> August, 2001 for his insightful guidance and knowledge.

To the countless people who mail me with praise, constructive criticism, suggestions and advice... a HUGE thank you!

And of course, all the guys and gals at Balbardie Archery Club and the Grange Archery Club.

Oh yes – and anyone I may have forgotten!



**HIT THE GOLD!**